

VACUUM PUMP SYSTEM LABOPORT® SC 840 G



Technical features

- Automatic, accurate recognition and monitoring of the boiling point using the integrated ramp function
- No solvent library needed
- High recovery rates even with low boiling point solvents
- Remote-controlled for safe operation from outside closed fume hoods
- Easy, intuitive control via touchscreen display and precise rotation knob
- Four operating modes for nearly all common lab applications
- Integrated rotation speed control for precise vacuum control
- Integrated gas ballast valve
- Environmentally friendly
- ATEX compliant to (Ex) II 3/-G Ex h IIB+H2 T3 Gc internal atmosphere only

Technical data

Flow rate [m³/h] at atm. pressure	2,04
Flow rate [l/min] at atm. pressure	34
Ultimate vacuum [mbar abs.]	6,0
Operating pressure [bar]	0,1
Voltage [V]	100 – 240
Frequencies [Hz]	50/60
Protection class	IP30
Power P ₁ [W]	60
Operating current [A]	0,6 (240 V AC) 1,0 (100 V AC)
With thermal switch and power fuse	

REMOTE-CONTROL UNIT/CONTROLLER

Connectivity	USB-A (Bluetooth) USB-Mini/USB-C (Cable connection)
Power supply in remote-control operation	Via integrated batteries or using the wireless charger included
Battery operating life	max. 8 h
Operation of the device	Touchscreen/ Rotary/push knob
Weight [kg]	Controller: 0,69 Docking station: 0,26
Battery type	Nickel-metal hybrid (Ni/Mh)

MATERIALS

Pump head	TFM™ PTFE
Diaphragm	PTFE-beschichtet
Valves	FFPM

OTHER DATA

Weight [kg]	15,75
Hose connections	Inlet: For hose ID 8 – 9,5 Outlet: For hose ID 10
Dimensions W x H x D [mm]	Vacuum pump system: 366 x 416 x 274 Controller: 162 x 96 x 51 Docking station: 96 x 88 x 101
Permissible media and ambient temperature [°C]	+5 bis +40

SPARE PARTS

SPARE PARTS	ID
Spare parts kit pump N 840 G	331052
Spare parts kit System SC 840 G	338824

Dimensions

SC 840 G

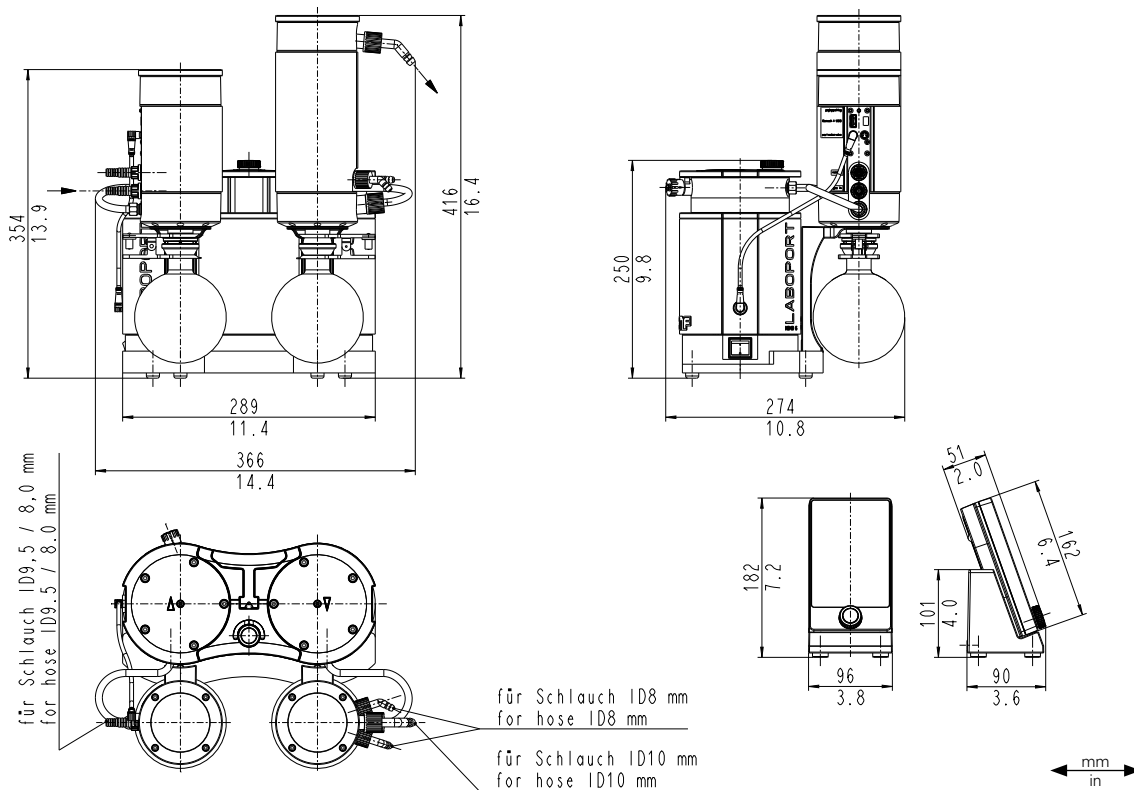

Performance Characteristics

PUMP DOWN TIME FOR 20 LITER RECEIVER

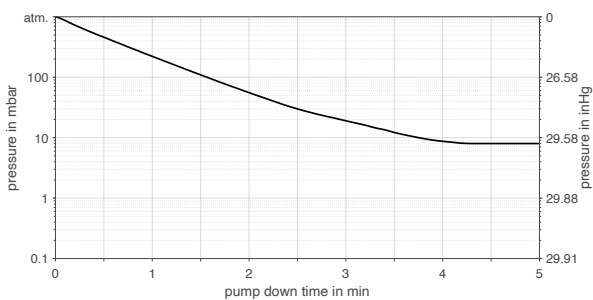

SUCTION PUMPING SPEED AT MIN./MAX. MOTOR SPEED

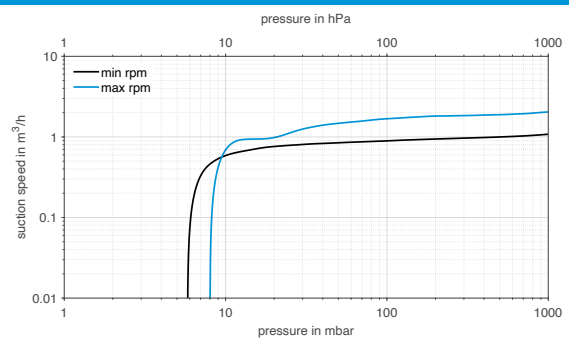

ACCESSORIES	ID
Separator flask	047729
High performance condenser with pressure relief valve	114855
Hose connector with O-ring (FPM)	323609
Hose connector PP (for hose ID 10)	026237
Screw connection cap red, GL 18 (for hose connector ID 026237)	025980
Hose connector PP (for hose ID 8)	025981

Screw connection cap red, GL 14 (for hose connector ID 025981)	025982
Key for hose connector	316279
Hose-BGR for Separator flask (1x for SC 840 G)	329998
Hose BGR for high performance condenser (1x for SC 840 G)	317157
Docking station controller	336784
Battery pack controller	339004