

# FL 10 DIAPHRAGM LIQUID PUMP



## ADVANTAGES

- Valve function when switched off prevents uncontrolled flow of the media
- Long lifetime and maintenance-free
- IP 65 protection class for operation in harsh environments
- Integrated overpressure limit
- Good controllability of the flow rate by means of PFM signal
- Self priming and dry-run safe

## POSSIBLE AREAS OF USE

- Analytical engineering
- Laboratory technology
- Cleaning industry
- Inkjet printing
- Medical technology
- Water treatment

Please visit our website  
[www.knf.com](http://www.knf.com)  
to get more information.

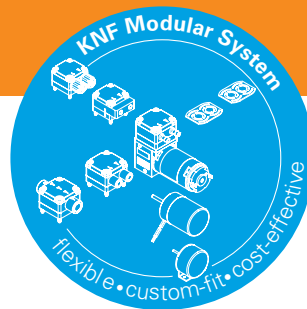

## PERFORMANCE DATA

Series model	FL 10			
Material options	KP	KT	RP	RT
Pump head	PP		PPS	
Diaphragm	PTFE		PTFE	
Resonating diaphragm	EPDM	FFKM	EPDM	FFKM
Valves	EPDM	FFKM	EPDM	FFKM
Flow rate at atm. pressure (ml/min)	100 (90 on AC 115 V / 60 Hz)			
Suction height (mWg)	2	1.5	2	2
Pressure head (mWg)	10			
Permissible ambient air (°C)	-5 to 60			
Permissible liquid temperature (°C)	5 to 80			
Weight (g)	173			
IP protection factor	65			

## ELECTRICAL DATA

Drive options	DC-P 24 V	AC 230 V / 50 Hz	AC 115 V / 60 Hz
Operating voltage (V)	24	230	115
Power consumption (W)	7.7	7.1	5.8
Operating current (A)	0.87	0.1	0.18

# FL 10 DC-P

## PERFORMANCE DATA

Series model	Flow rate at atm. pressure (ml/min)	Max. suction height (mWg)	Max. pressure head (mWg)
FL 10 DC-P KP	100 +/-10ml/min	2	10
FL 10 DC-P KT	100 +/-10ml/min	1.5	10
FL 10 DC-P RP	100 +/-10ml/min	2	10
FL 10 DC-P RT	100 +/-10ml/min	2	10

## FL 10 DC-P

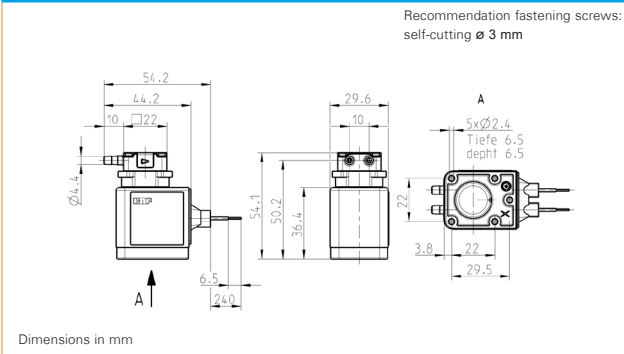

## FL 10 DC-P FLOW CURVE

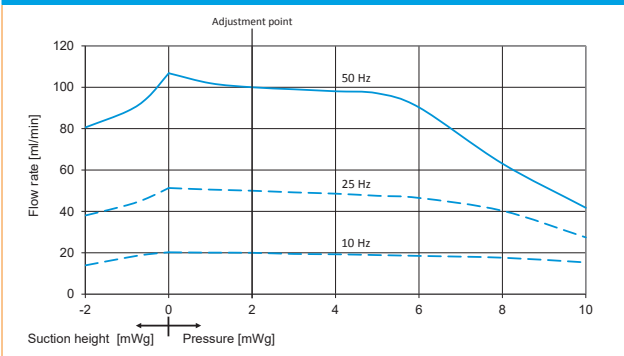

## FL 10 DC-P ACTUATION (EXTERNAL)

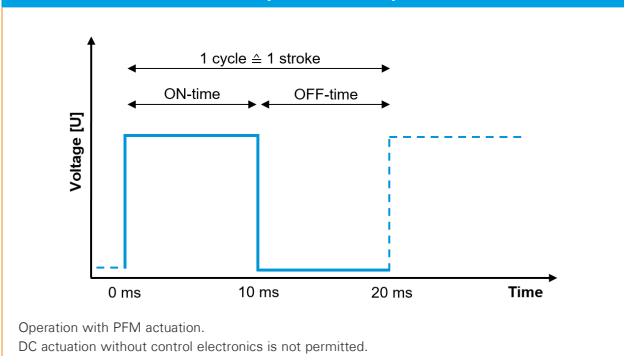

## ACTUATION PARAMETERS FL 10 DC-P

Operating voltage U	24 V
Input signal	PFM (Pulse Frequency Modulation)
Operating frequency	0-50 Hz
ON-time	10 ms
OFF-time	$\geq$ 10 ms
Min. dielectric strength of external circuit breaker	70 V
Continuous current supply	Not permissible

## ELECTRONIC SPECIFICATIONS FL 10 DC-P

Strands	2 x AWG22 PTFE, not polarized
Insulation material class	H (180° C)
Protective function	Overvoltage protection against counterinduction of the coil integrated, no additional freewheeling diode permissible

# FL 10 AC

## PERFORMANCE DATA

Series model	Flow rate at atm. pressure (ml/min)	Max. suction height (mWg)	Max. pressure head (mWg)
FL 10 AC 230 V KP	100 +/-10ml/min	2	10
FL 10 AC 230 V KT	100 +/-10ml/min	1.5	10
FL 10 AC 115 V KP	90 +/-10ml/min	1.5	10
FL 10 AC 115 V KT	90 +/-10ml/min	1.5	10

## FL 10 AC

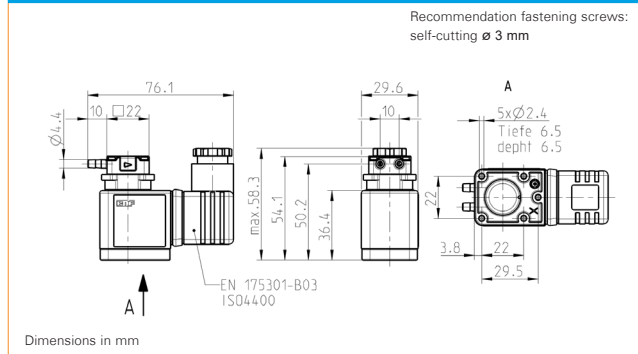

## FL 10 AC FLOW CURVE

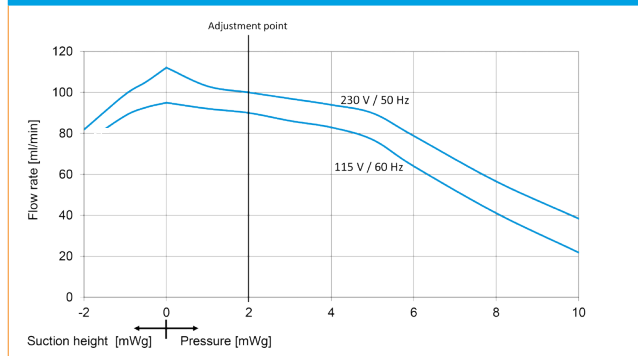

## FL 10 AC ACTUATION

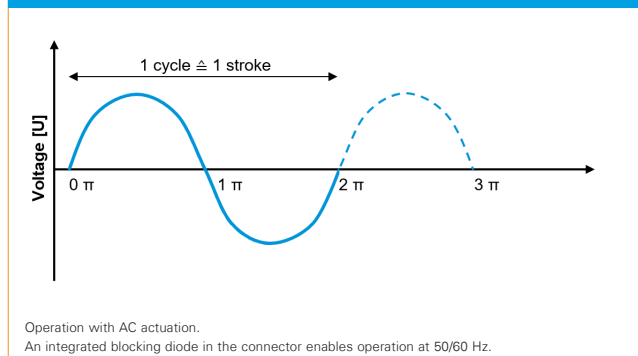



## ACTUATION PARAMETERS FL 10 AC

Operating voltage U	230 V/50 Hz	115 V/60 Hz
Input signal	AC Sinus	AC Sinus
Operating frequency	50 Hz	60 Hz
Min. dielectric strength of external circuit breaker	900 V	500 V

## ELECTRONIC SPECIFICATIONS FL 10 AC



Connector	EN175301-803 ISO4400 with integrated blocking diode, suitable for cables with $\varnothing$ 5-7 mm
Connection terminal contacts	Ⓞ : L1 Ⓞ : N Ⓞ : PE
Insulation material class	H (180° C)
Protective function	Overvoltage protection against counterinduction of the coil integrated, no additional freewheeling diode permissible

OPTIONS		
Description	Illustration	Details
Drives		Various voltage options
Electrical connections		Molex, AMP etc.
Hydraulic connections		Internal thread, compression fittings, manifold connection etc.



**NSF National Sanitary Foundation**

This certification will confirm that all of the pumps with the code .51 are certified for the use with foods/consumables.

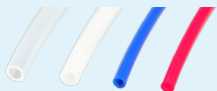
ACCESSORIES		
Description	Illustration	Details
Elastomer mounting kit		For easy and vibration dampening mounting of the pump in the customer system.
Diaphragm pressure control valve		The pressure control valve can be used for a more accurate control of flow against a fluctuating back pressure, metering into a vacuum and from a pressurised system.
Pulsation damper		This very versatile pulsation damper reduces the vibration in hoses and pipes and it helps to remove pulsation which is preventing the system from functioning correctly.
Filter		KNF filters protect both pumps and other upstream instrumentation and hydraulic circuits against particulate, crystals and fibres which can improve optimum operation.
Tubing		Various diameters and materials

The performance values for the series models shown on this data sheet were determined under test conditions. The actual performance values may differ and depend in particular on the usage conditions and therefore on the specific application, on the parameters of the components involved in the user's system and on any technical modifications carried out which deviate from the standard configuration or the as delivered condition.

If individual designs have been created for specific customers on the basis of series models, other technical performance data may apply. Before operation begins, the relevant operating instructions and/or assembly or installation instructions should be read and the safety information contained in these instructions should be noted. KNF reserves the right to make changes to the product and the associated documentation without prior notice to the customer.



[www.knf.com](http://www.knf.com)

KNF reserves the right to make technical changes without notice.  
KNF 04/2025. [www.knf.com](http://www.knf.com)