

FMM 20

DIAPHRAGM LIQUID PUMP WITH LINEAR DRIVE



FMM 20 KPDC-P



FMM 20 TTDC-P

ADVANTAGES

- Long lifetime
- Adjustable dispense volume 5-17 μ l
- Large flow range
- Flow tight in both directions
- High chemical resistance
- Self priming
- Quiet running

POSSIBLE AREAS OF USE

- Medical diagnostics
- Industrial dosing systems
- Inkjet printing
- Fuel cells
- Semi conductor industry
- Water analysis

Please visit our website
www.knf.com
 to get more information.

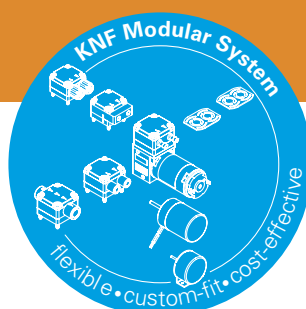

PERFORMANCE DATA

Series model	FMM 20 DC-P		
Material options	KP	KT	TT
Pump head	PP	PP	PVDF
Diaphragm	EPDM	FFKM	FFKM
Valves	EPDM	FFKM	FFKM
Nominal stroke volume (μ l)	15		
Stroke volume calibration range (μ l)	5-17		
Flow rate at 20 Hz (ml/min)	18		
Suction height (mWg)	3		
Pressure head (mWg)	10		
Permissible ambient air ($^{\circ}$ C)	+5 to +40		
Permissible liquid temperature ($^{\circ}$ C)	+5 to +80		
Weight (g)	88		
IP protection factor	54		

ELECTRICAL DATA

Operating voltage (V)	12	24
Max. permissible frequency (Hz)	20	
I load max. during impulse (A)	1.45	0.6
Effective cont. current consumption at 20 Hz (A)	0.85	0.36
Effective cont. power consumption at 20 Hz (W)	8.04	7.2

FMM 20 DC-P

PERFORMANCE DATA

Series model	Nominal stroke volume (µl)	Flow rate at 20 Hz (ml/min)	Suction height (mWS)	Pressure head (mWS)
FMM 20 DC-P	15	18	3	10

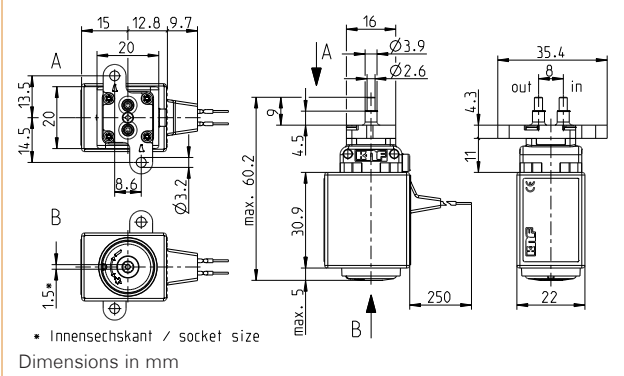

FMM 20 DC-P

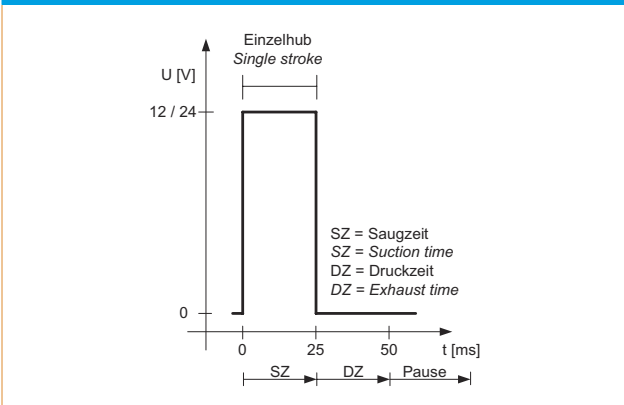

CONTROL SIGNAL (IMPULSE)



OPTIONS		
Description	Illustration	Details
Hydraulic connections		Internal threads, compression fittings, manifold etc.

ACCESSORIES		
Description	Illustration	Details
Diaphragm pressure control valve		The pressure control valve can be used for a more accurate control of flow against a fluctuating back pressure, metering into a vacuum and from a pressurised system.
Pulsation damper		This very versatile pulsation damper reduces the vibration in hoses and pipes and it helps to remove pulsation which is preventing the system from functioning correctly.
Filter		KNF filters protect both pumps and other upstream instrumentation and hydraulic circuits against particulate, crystals and fibres which can improve optimum operation.

The performance values for the series models shown on this data sheet were determined under test conditions. The actual performance values may differ and depend in particular on the usage conditions and therefore on the specific application, on the parameters of the components involved in the user's system and on any technical modifications carried out which deviate from the standard configuration or the as delivered condition.

If individual designs have been created for specific customers on the basis of series models, other technical performance data may apply. Before operation begins, the relevant operating instructions and/or assembly or installation instructions should be read and the safety information contained in these instructions should be noted. KNF reserves the right to make changes to the product and the associated documentation without prior notice to the customer.



www.knf.com