

NMP015 SERIES MICRO DIAPHRAGM GAS PUMPS

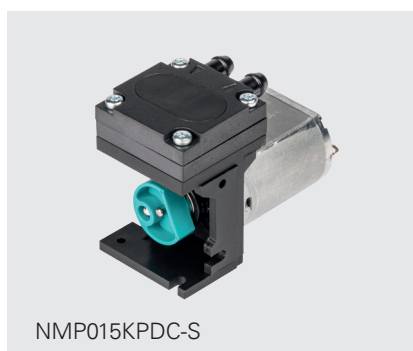

NMP015KPDC-S



NMP015KPDC-L



NMP015KPDC-B

ADVANTAGES

- Customizing available
- Tested to customers specs
- High performance to size, efficiency and weight ratio
- Excellent reliability/durability
- Speed controllable
- Low sound level
- Long service life
- Uncontaminated transfer
- Maintenance-free
- High chemical resistance
- Can be installed in any position

POSSIBLE AREAS OF USE

- Medical devices
- Analytical equipment
- Emission measurement
- Reprographic
- Degassing
- Safety/Security
- Portable devices

Please visit our website
www.knf.com
to get more information.

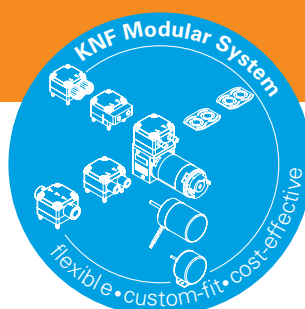

PERFORMANCE DATA

Series Model	NMP015					
Material design	KPDC-S	KPDC-M		KPDC-L	KPDC-B	
Pump head	PPS					
Diaphragm	EPDM (PTFE on request)					
Valves	EPDM (FFKM on request)					
Flow rate at atm. pressure (l/min)	1.3	1.5	1.6	1.4	1.3	1.3
Ultimate vacuum (mbar abs.)	450	400	400	400	400	400
Ultimate pressure (bar rel)	0.85	0.9	0.9	0.9	0.9	0.9
Permissible media and ambient temperature (° C/° F)	+5° C to +40° C / 41° F to 104° F (extended temperature on request)					
Weight (g/oz)	44/1.55	63/2.22		47/1.66	55/1.94	

ELECTRICAL DATA

Voltage (V)	6	6	12	6	6	12
Motor	DC	DC		DC	Brushless DC	
I _{max} (A)	0.32	0.39	0.21	0.29	0.31	0.17

NMP015KPDC-S

PERFORMANCE DATA

Series model	Flow rate at atm. pressure (l/min)	Max. operating pressure (bar rel)	Ultimate vacuum (mbar abs.)
NMP015KPDC-S 6V	1.3	0.85	450

NMP015KPDC-S

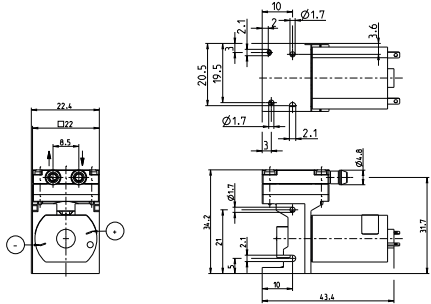

Dimensions in mm

NMP015KPDC-S 6V FLOW CURVE

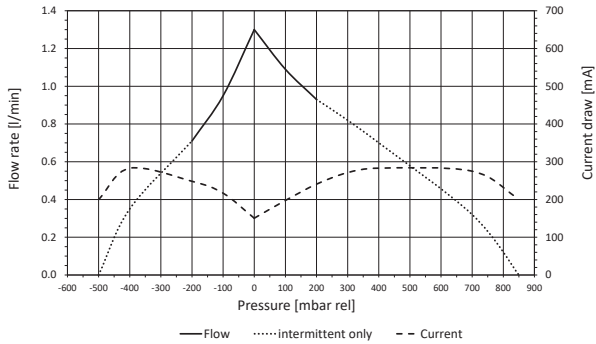

NMP015KPDC-M

PERFORMANCE DATA

Series model	Flow rate at atm. pressure (l/min)	Max. operating pressure (bar rel)	Ultimate vacuum (mbar abs.)
NMP015KPDC-M 6V	1.5	0.9	400
NMP015KPDC-M 12V	1.6	0.9	400

NMP015KPDC-M

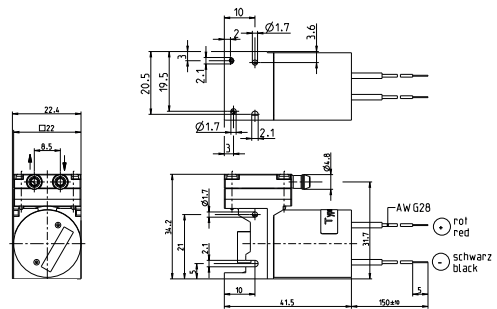

Dimensions in mm

NMP015KPDC-M 6V FLOW CURVE

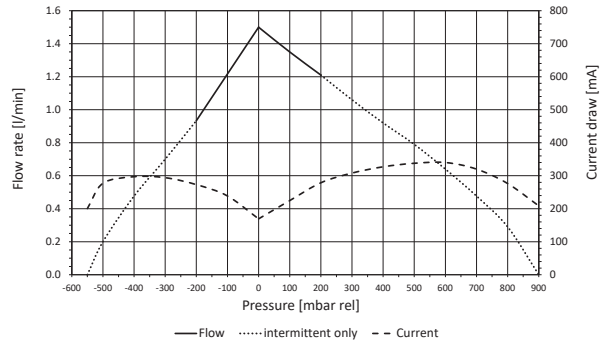

NMP015KPDC-M 12V FLOW CURVE

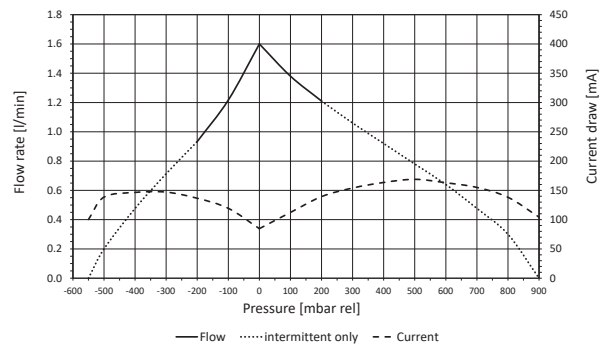

NMP015KPDC-L

PERFORMANCE DATA

Series model	Flow rate at atm. pressure (l/min)	Max. operating pressure (bar rel)	Ultimate vacuum (mbar abs.)
NMP015KPDC-L 6V	1.4	0.9	400

NMP015KPDC-L

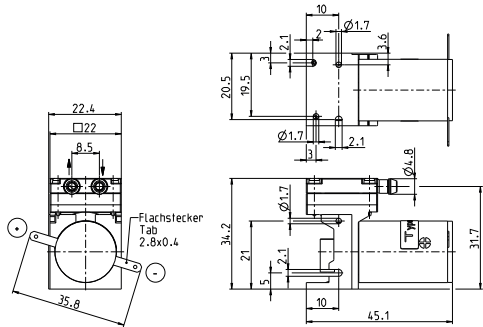

Dimensions in mm

NMP015KPDC-L 6V FLOW CURVE

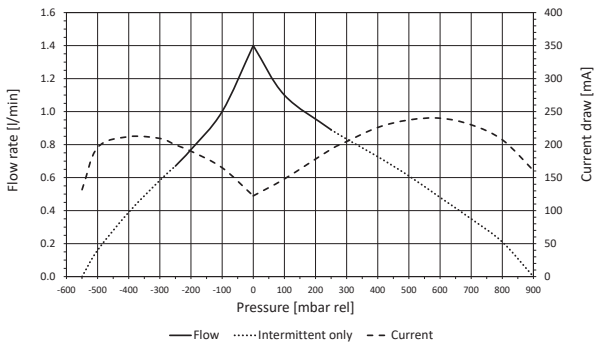

NMP015KPDC-B

PERFORMANCE DATA

Series model	Flow rate at atm. pressure (l/min)	Max. operating pressure (bar rel)	Ultimate vacuum (mbar abs.)
NMP015KPDC-B 6V	1.3	0.9	400
NMP015KPDC-B 12V	1.3	0.9	400

NMP015KPDC-B

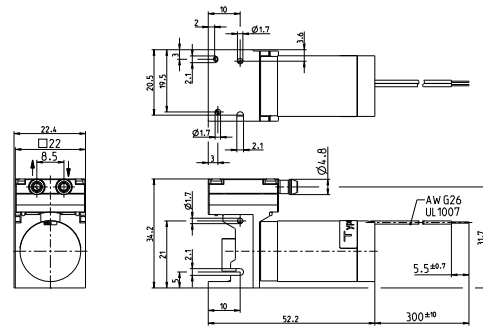



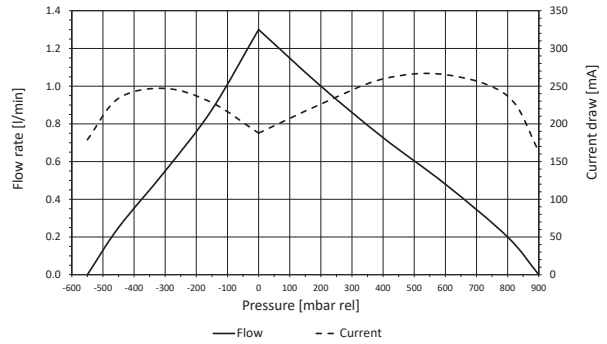

Dimensions in mm

NMP015KPDC-B 6V FLOW CURVE

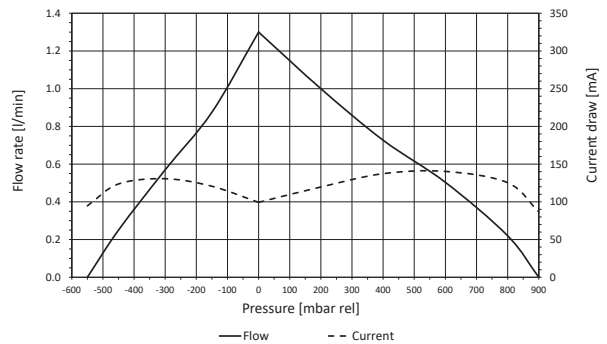

NMP015KPDC-B 12V FLOW CURVE



OPTIONS			
Description	Illustration	Part No.	Details
Motors		On request	Other motors and voltages on request.
Eccentric		On request	Different eccentricities on request.
Housing cover		On request	Project pumps only.

The performance values for the series models shown on this data sheet were determined under test conditions. The actual performance values may differ and depend in particular on the usage conditions and therefore on the specific application, on the parameters of the components involved in the user's system and on any technical modifications carried out which deviate from the standard configuration or the as delivered condition.

If individual designs have been created for specific customers on the basis of series models, other technical performance data may apply. Before operation begins, the relevant operating instructions and/or assembly or installation instructions should be read and the safety information contained in these instructions should be noted. KNF reserves the right to make changes to the product and the associated documentation without prior notice to the customer.



www.knf.com