

NMP03 SERIES MICRO DIAPHRAGM GAS PUMPS



NMP03KPDC-M



NMP03KPDC-L



NMP03KPDC-B1

ADVANTAGES

- Customizing available
- Tested to customers specs
- High performance to size, efficiency and weight ratio
- Excellent reliability/durability
- Speed controllable
- Low sound level
- Long service life
- Uncontaminated transfer
- Maintenance-free
- High chemical resistance
- Can be installed in any position

POSSIBLE AREAS OF USE

- Medical devices
- Analytical equipment
- Emission measurement
- Reprographic
- Degassing
- Safety/Security
- Portable devices

Please visit our website
www.knf.com
to get more information.

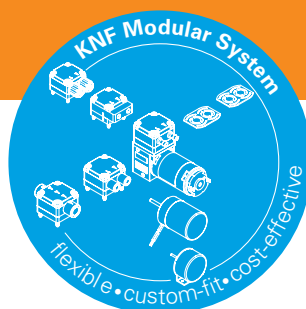

PERFORMANCE DATA

Series model	NMP03				
Material design	KPDC-S	KPDC-M	KPDC-L	KPDC-B1	KPDC-B3
Pump head	PPS				
Diaphragm	EPDM (FKM and FFKM on request)				
Valves	EPDM (FKM and FFKM on request)				
Flow rate at atm. pressure (l/min)	0.33	0.33	0.33	0.33	0.33
Ultimate vacuum (mbar abs.)	600	600	600	600	600
Ultimate pressure (mbar rel)	330	330	330	330	330
Permissible media and ambient temperature (° C/° F)	-20° C to +60° C (-4° F to 140° F)				
Weight (g/oz)	10.8/0.38	13.9/0.49	13.1/0.46	10.9/0.38	12.7/0.45

ELECTRICAL DATA

Voltage (V)	3	1.5	2.6	3.9	3.9
Motor	DC	DC	DC	Brushless DC without electronic	Brushless DC with external electronic
I _{max} (mA)	93	155	80	62	62

NMP03KPDC-S

PERFORMANCE DATA

Series model	Flow rate at atm. pressure (l/min)	Max. operating pressure (mbar rel)	Ultimate vacuum (mbar abs.)
NMP03KPDC-S 3V	0.33	330	600

NMP03KPDC-S

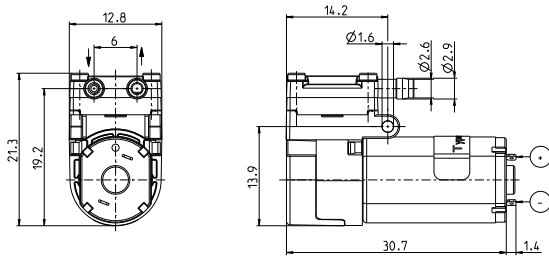

Dimensions in mm

NMP03KPDC-M

PERFORMANCE DATA

Series model	Flow rate at atm. pressure (l/min)	Max. operating pressure (mbar rel)	Ultimate vacuum (mbar abs.)
NMP03KPDC-M 1.5V	0.33	330	600

NMP03KPDC-M

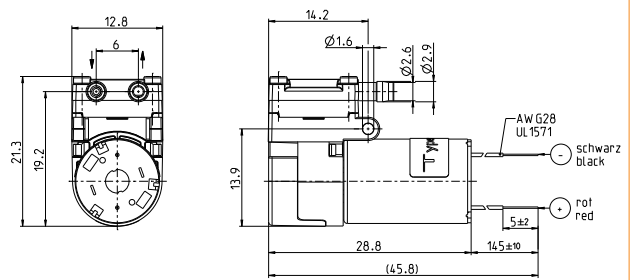

Dimensions in mm

NMP03KPDC-S 3V

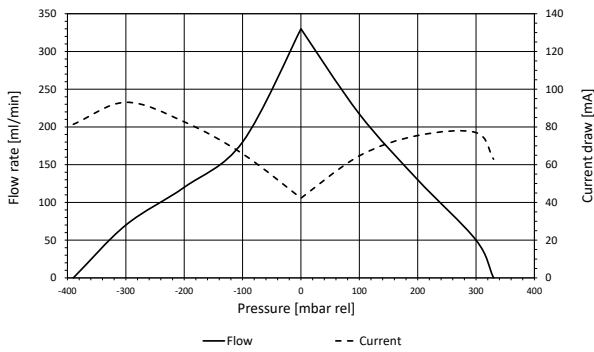

NMP03KPDC-M 1.5V

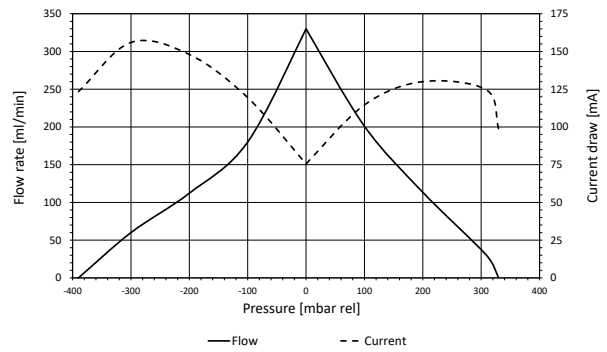

LINEARITY NMP03KPDC-S

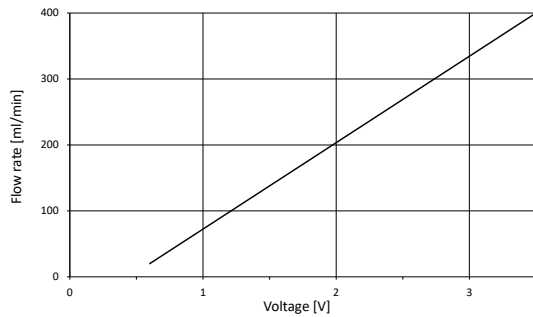

LINEARITY NMP03KPDC-M

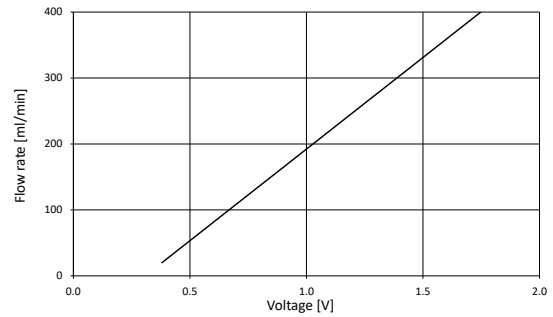

NMP03KPDC-L

PERFORMANCE DATA

Series model	Flow rate at atm. pressure (l/min)	Max. operating pressure (mbar rel)	Ultimate vacuum (mbar abs.)
NMP03KPDC-L 2.6V	0.33	330	600

NMP03KPDC-L

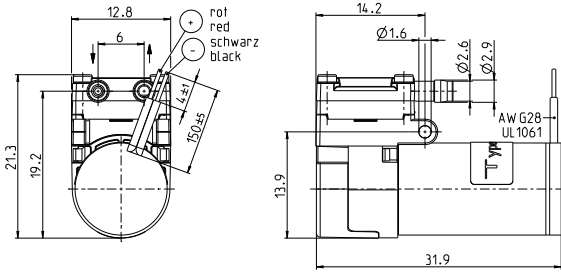

Dimensions in mm

NMP03KPDC-B1/DC-B3

PERFORMANCE DATA

Series model	Flow rate at atm. pressure (l/min)	Max. operating pressure (mbar rel)	Ultimate vacuum (mbar abs.)
NMP03KPDC-B1/DC-B3 3.9V	0.33	330	600

NMP03KPDC-B1/DC-B3

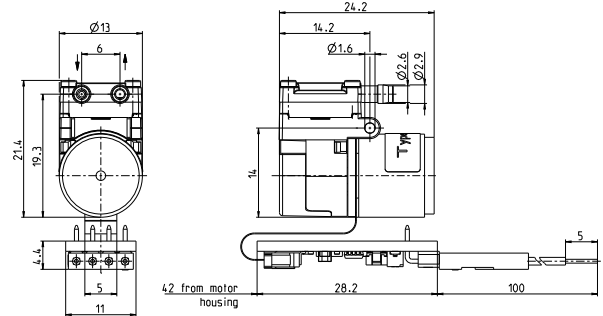

Dimensions in mm

NMP03KPDC-L 2.6V

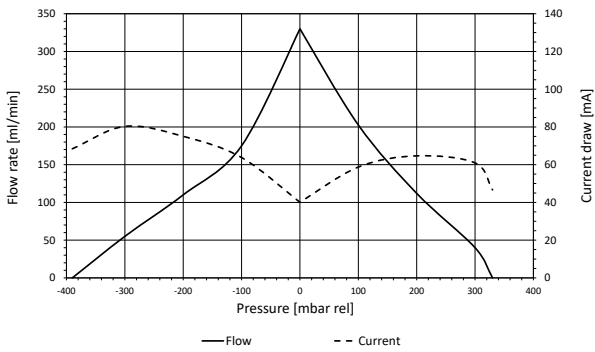

NMP03KPDC-B1/DC-B3 3.9V

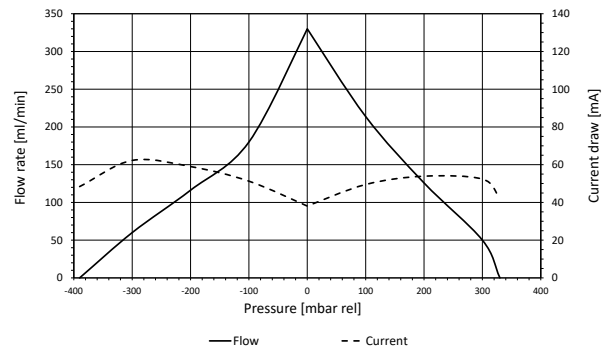

LINEARITY NMP03KPDC-L

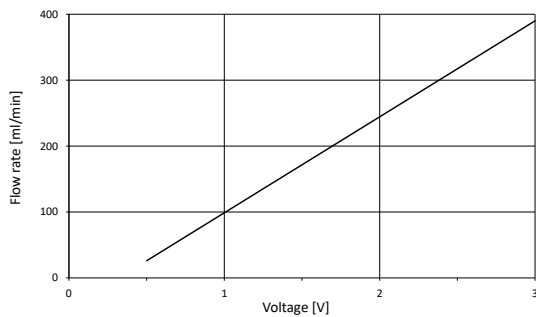

LINEARITY NMP03KPDC-B1/DC-B3

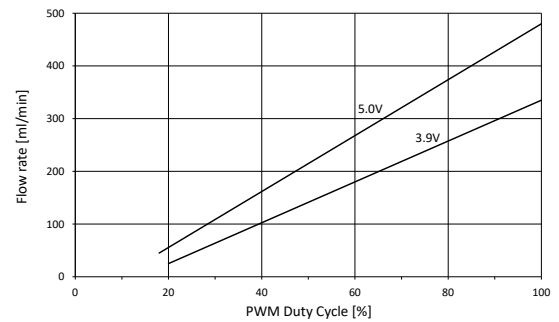

OPTIONS			
Description	Illustration	Part No.	Details
Motors		On request	Other motors and voltages on request.
Connecting plate		On request	Customer specific connecting plates on request.
Eccentric		On request	Different eccentricities on request.

The performance values for the series models shown on this data sheet were determined under test conditions. The actual performance values may differ and depend in particular on the usage conditions and therefore on the specific application, on the parameters of the components involved in the user's system and on any technical modifications carried out which deviate from the standard configuration or the as delivered condition.

If individual designs have been created for specific customers on the basis of series models, other technical performance data may apply. Before operation begins, the relevant operating instructions and/or assembly or installation instructions should be read and the safety information contained in these instructions should be noted. KNF reserves the right to make changes to the product and the associated documentation without prior notice to the customer.



www.knf.com