

N 922 FT SERIES – 60 HZ VERSION

CHEMICALLY RESISTANT GAS SAMPLING PUMPS

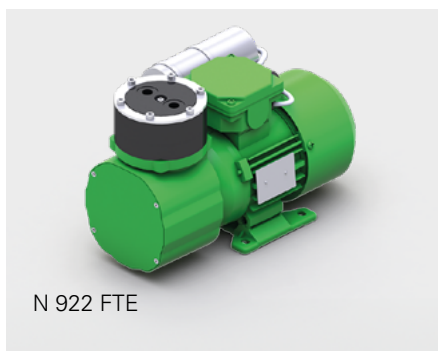

N 922 FTE

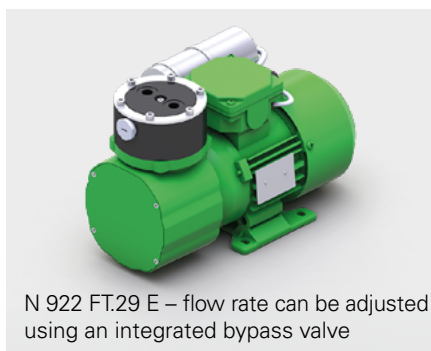

N 922 FT.29 E – flow rate can be adjusted using an integrated bypass valve

ADVANTAGES

- High chemical resistance
- Robust design
- Easy to service – wearing parts are inexpensively and easy to replace
- Maintenance work can be easily carried out even on assembled analytical systems
- Durable even with difficult operating conditions

POSSIBLE AREAS OF USE

- Environmental monitoring – especially in stationary emission measurement technology (CEMS)
- Process industry
- Chemical industry

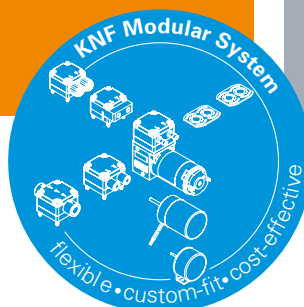

Please visit our website
www.knf.com
 to get more information

PERFORMANCE DATA				
Series model	N 922 8L		N 922 16L	
Material design	FTE	FT.29 E	FTE	FT.29 E
Pump head	Modified PTFE			
Diaphragm	PTFE-coated			
Valves	FFPM			
Flow rate at atm. pressure (l/min)	9.0 ± 10 %	4.0–9.0 ± 10 %	18.0 ± 10 %	12.0–18.0 ± 10 %
Ultimate vacuum (mbar abs.)	350		200	
Max. operating pressure (bar rel./psig)	1.5/21.8		2.0/29.0	
Permissible ambient temperature (°C)	+5 ... +60 – 0 if frost-free (non-condensing)			
Permissible media temperature (°C)	0 ... +60			
Weight (kg/lbs)	7.3/16.1			
ELECTRICAL DATA				
Voltage (V) Capacitor motor	115 100 220		115 100 220	
Protection class motor	IP 54			
Protection class pump	IP 54			
Frequency (Hz)	60			
Power P ₁ (W) Capacitor motor	120 100 120		140 120 170	
I _{max} (A) Capacitor motor	1.1 1.1 0.9		1.3 1.3 0.9	

N 922 FTE 8L – 60 HZ VERSION

PERFORMANCE DATA

Series model	Flow rate at atm. pressure (l/min)	Max. operating pressure (bar rel./psig)	Ultimate vacuum (mbar abs.)
N 922 FTE 8L	9.0 ± 10 %	1.5/21.8	350

Flow rate determined at 20 °C, 1013 mbar abs.
(Pressure 0 to 1013 mbar abs. in accordance with ISO 21360-1/2)

N 922 FTE 8L

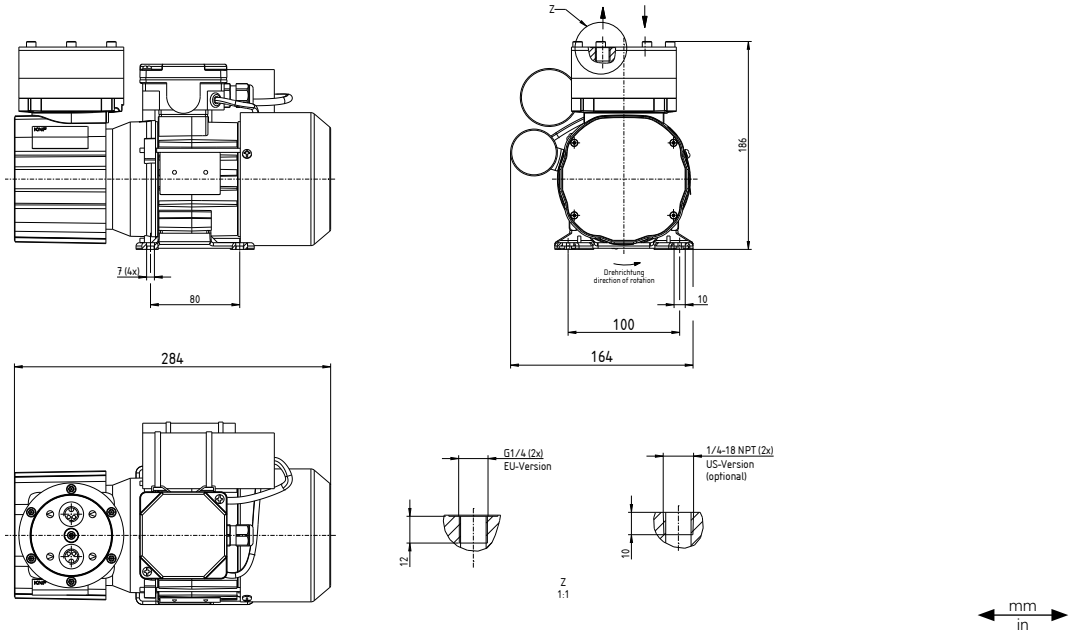

N 922 FTE 8L

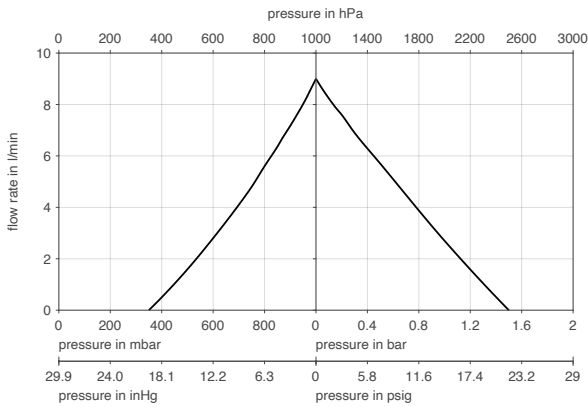

Flow rate determined at 20°C, 1013 mbar abs.
(Pressure 0 to 1013 mbar abs. in accordance with ISO 21360-1/2)

N 922 FTE 8L | PUMP UP TIME FOR 20 LITER VESSEL

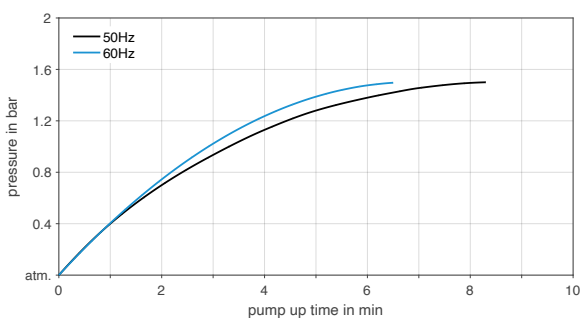

N 922 FTE 8L | PUMP DOWN TIME FOR 20 LITER VESSEL

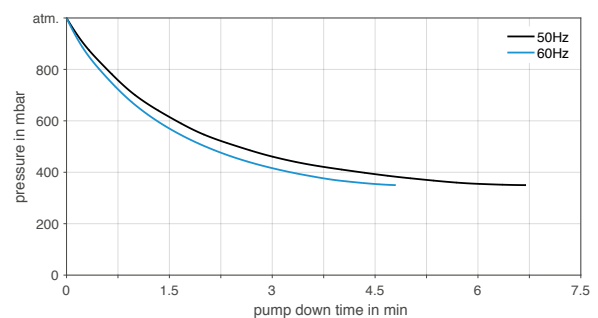

N 922 FT.29 E 8L – 60 HZ VERSION

PERFORMANCE DATA

Series model	Flow rate at atm. pressure (l/min)	Max. operating pressure (bar rel./psig)	Ultimate vacuum (mbar abs.)
N 922 FT.29 E 8L	4.0-9.0 ± 10 %	1.5/21.8	350

Flow rate determined at 20 °C, 1013 mbar abs.

(Pressure 0 to 1013 mbar abs. in accordance with ISO 21360-1/2)

N 922 FT.29 E 8L

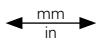
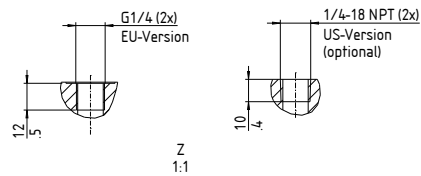
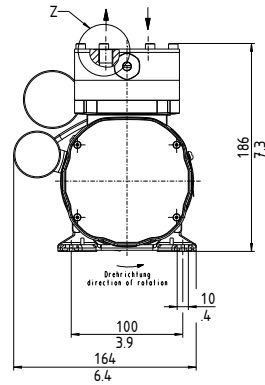
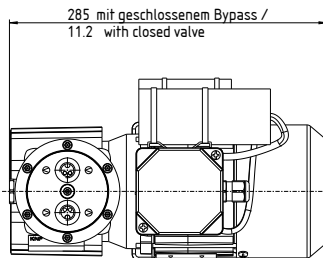
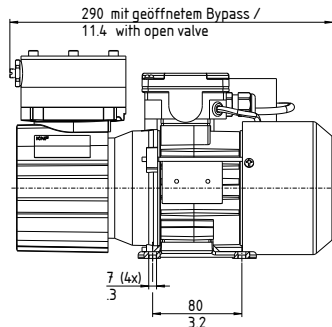

N 922 FT.29 E 8L

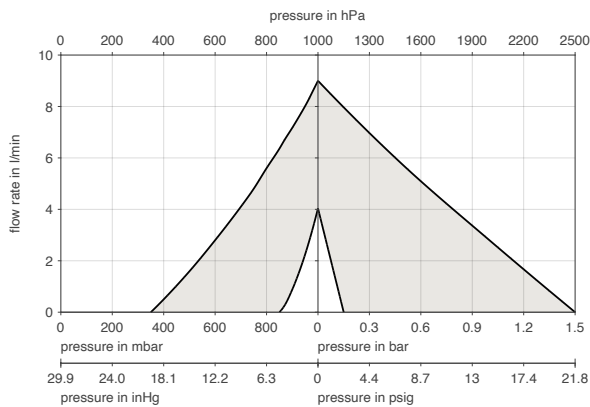

Flow rate determined at 20°C, 1013 mbar abs.

(Pressure 0 to 1013 mbar abs. in accordance with ISO 21360-1/2)

N 922 FT.29 E 8L | PUMP UP TIME FOR 20 LITER VESSEL

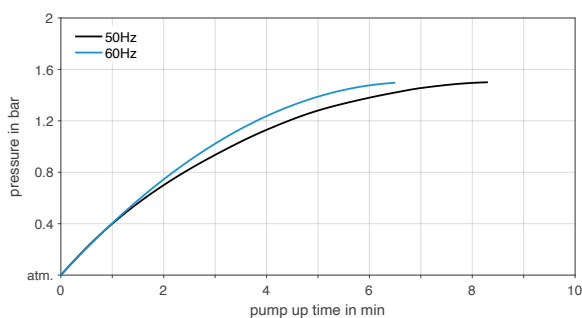

N 922 FT.29 E 8L | PUMP DOWN TIME FOR 20 LITER VESSEL

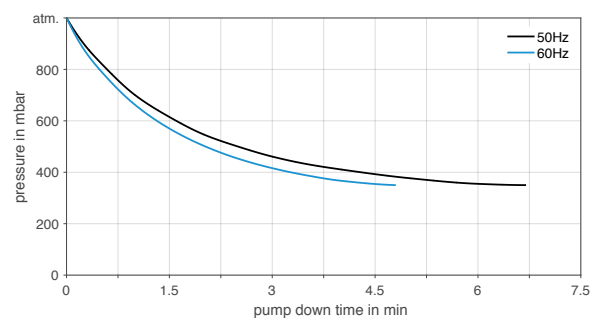

N 922 FTE 16L – 60 HZ VERSION

PERFORMANCE DATA

Series model	Flow rate at atm. pressure (l/min)	Max. operating pressure (bar rel./psig)	Ultimate vacuum (mbar abs.)
N 922 FTE 16L	18.0 ± 10 %	2.0/29.0	200

Flow rate determined at 20 °C, 1013 mbar abs.

(Pressure 0 to 1013 mbar abs. in accordance with ISO 21360-1/2)

N 922 FTE 16L

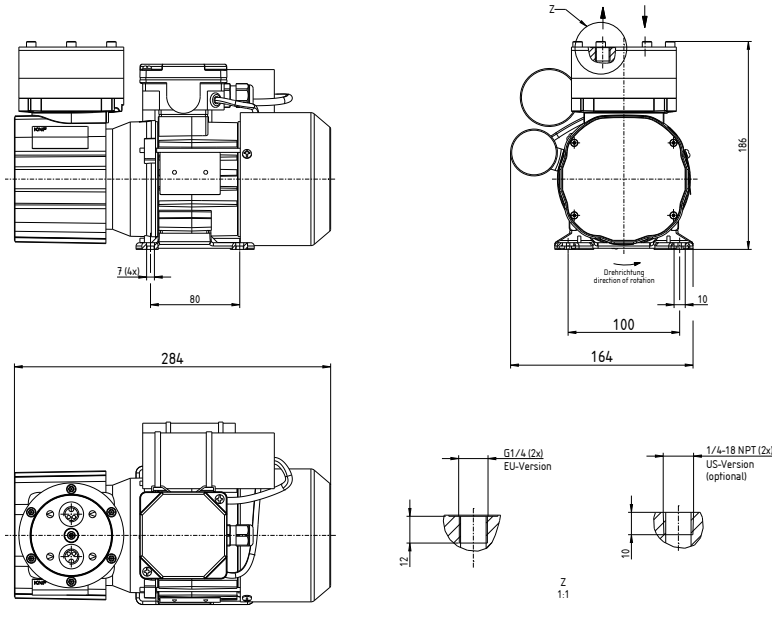

N 922 FTE 16L

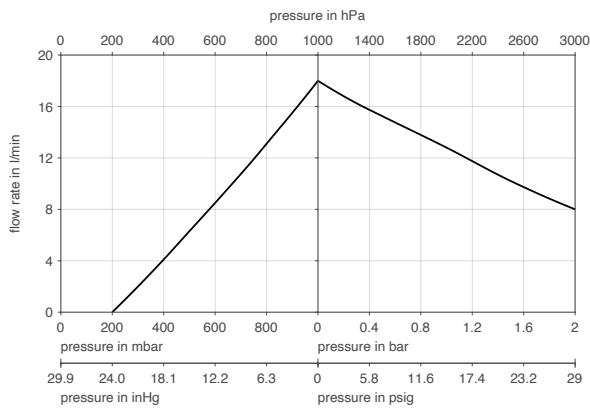

Flow rate determined at 20°C, 1013 mbar abs.

(Pressure 0 to 1013 mbar abs. in accordance with ISO 21360-1/2)

N 922 FTE 16L | PUMP UP TIME FOR 20 LITER VESSEL

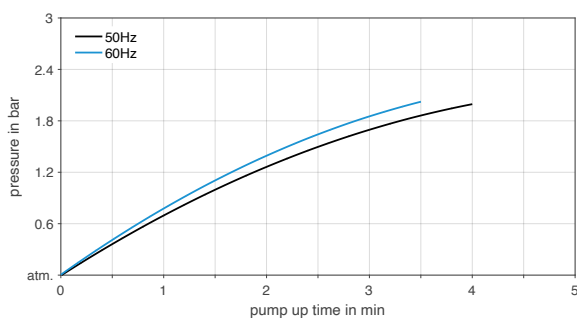

N 922 FTE 16L | PUMP DOWN TIME FOR 20 LITER VESSEL

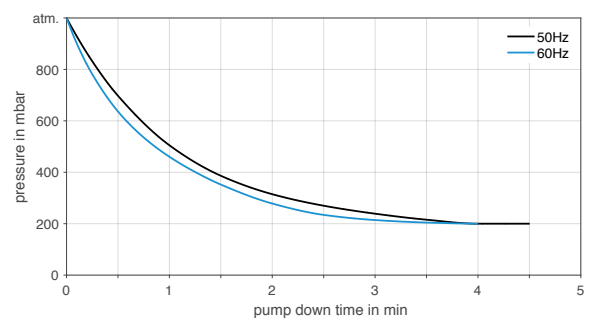

N 922 FT.29 E 16L – 60 HZ VERSION

PERFORMANCE DATA

Series model	Flow rate at atm. pressure (l/min)	Max. operating pressure (bar rel./psig)	Ultimate vacuum (mbar abs.)
N 922 FT.29 E 16L	12.0–18.0 ± 10 %	2.0/29.0	200

Flow rate determined at 20 °C, 1013 mbar abs.
(Pressure 0 to 1013 mbar abs. in accordance with ISO 21360-1/2)

N 922 FT.29 E 16L

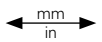
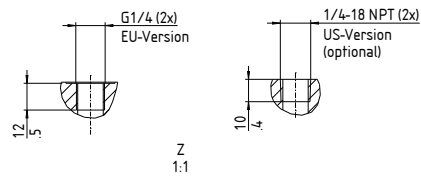
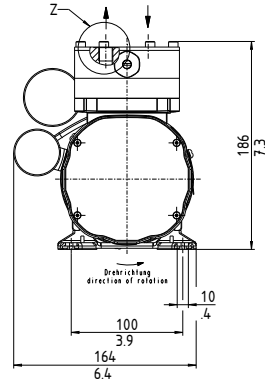
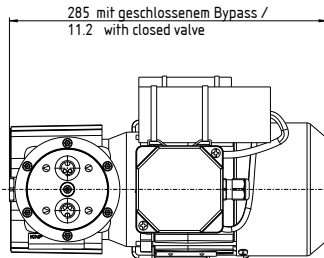
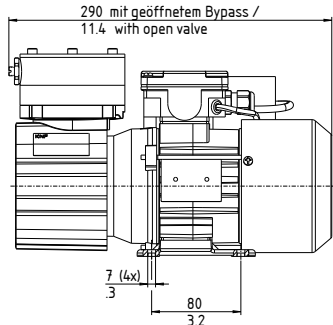

N 922 FT.29 E 16L

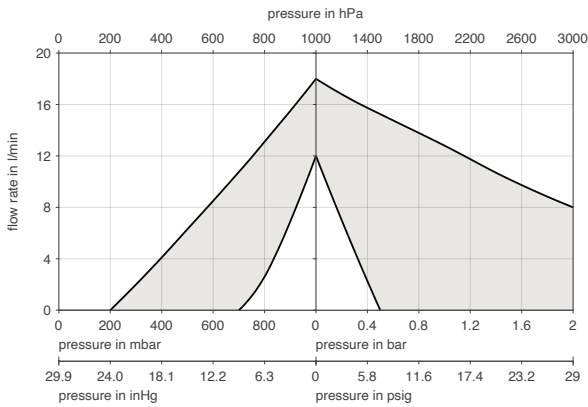

Flow rate determined at 20°C, 1013 mbar abs.
(Pressure 0 to 1013 mbar abs. in accordance with ISO 21360-1/2)

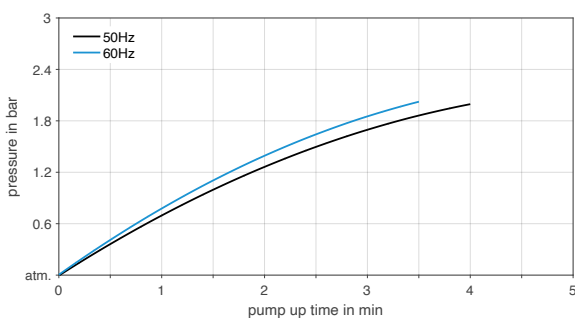

N 922 FT.29 E 16L | PUMP UP TIME FOR 20 LITER VESSEL

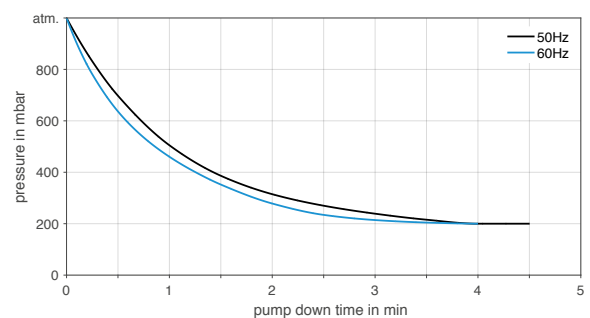

N 922 FT.29 E 16L | PUMP DOWN TIME FOR 20 LITER VESSEL

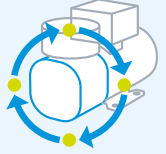

OPTIONS

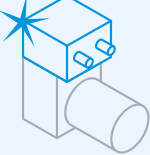
Description	Illustration	Details
Mechanical adjustment of pumping capacity		The pumping capacity can be adjusted at the factory to accommodate inlet pressure and for accurate alignment with the customer's system.
Pump housing can be rotated at 90° intervals		Pumps with a pump housing rotated at 90° intervals can be mounted at the factory. The customer may also rotate the pump housing later.
Pump with mounting bracket		The mounting bracket can be mounted at the factory.
Cleaned contact material parts		For the use of the pump with gases with high oxygen concentrations the parts that come into contact with the medium can be cleaned using a certified process.

ACCESSORIES

Description	Illustration	Part No.	Details
Tube fitting for tube ID 6, PVDF		303623	G 1/4
Mounting kit shock mounts		313180	
Mounting kit shock mounts and mounting bracket		313181	

SPARE PARTS

Description	Illustration	Part No.	Details
Spare parts kit N 922 FTE		313515	Spare parts kit consists of: 1x diaphragm, 2x valve plate/ sealing. This set is required to maintain the pump.
Spare parts kit N 922 FT.29 E		313516	Spare parts kit consists of: 1x diaphragm, 2x valve plate/ sealing, 1x O-ring. This set is required to maintain the pump.
Throttle valve (only for .29 versions)		309629	

The performance values for the series models shown on this data sheet were determined under test conditions. The actual performance values may differ and depend in particular on the usage conditions and therefore on the specific application, on the parameters of the components involved in the user's system and on any technical modifications carried out which deviate from the standard configuration or the as delivered condition.

If individual designs have been created for specific customers on the basis of series models, other technical performance data may apply. Before operation begins, the relevant operating instructions and/or assembly or installation instructions should be read and the safety information contained in these instructions should be noted. KNF reserves the right to make changes to the product and the associated documentation without prior notice to the customer.



www.knf.com