

N 630 SERIES

PROCESS VACUUM PUMPS AND COMPRESSORS



N 630 SP.9 E

ADVANTAGES

- High chemical resistance
- Durable even with difficult operating conditions
- High level of gas tightness
- Ambient temperatures of up to 60 °C possible with water cooling
- Stable transfer rate at all pressure levels throughout process
- Quiet operation with minimal vibration
- .12 version with additional safety diaphragm for preventing gas from escaping through cracks in the working diaphragm

POSSIBLE AREAS OF USE

- Environmental monitoring
- Process industry
- Chemical industry
- Energy technology – e.g. pressure increase for natural gas
- Gas recovery – e.g. in cryostats

Please visit our website
www.knf.com
 to get more information

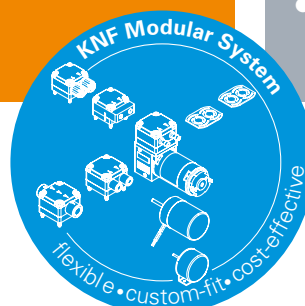

PERFORMANCE DATA

Series model	N 630 - 50 60 Hz Version				
Material design	ST.9 E / ST.13 E	ST.12 E	SP9 E / SP.13 E	SP.12 E	
Pump head	Stainless steel				
Diaphragm	PTFE-coated			EPDM	
Valves	Stainless steel				
Flow rate at atm. pressure (l/min)	30.0 35.0				
Ultimate vacuum (mbar abs.)	120				
Max. operating pressure (bar rel./psig)	7.0/101.5	3.0/43.5	7.0/101.5	3.0/43.5	
Permissible ambient temperature (°C)	+5 ... +60 (+40 without water cooling)				
Permissible media temperature (°C)	+5 ... +60 (+40 without water cooling)				
Level of gas tightness (mbar x l/s) .9/.13/.12	6 x 10 ⁻³ / 5 x 10 ⁻⁵ / 5 x 10 ⁻⁵				
Weight (kg/lbs)	36.0/79.4	38.0/83.8	36.0/79.4	38.0/83.8	

ELECTRICAL DATA

Voltage (V)	230/400	200/346	220/380	277/480	
Motor	Three-phase motor				
Protection class motor	IP 55				
Protection class pump	IP 20				
Frequency (Hz)	50	50	60	60	60
Power P ₁ (W)	350	320	350	360	350
I _N (A), 50 Hz	3.3/1.9	3.3/1.9	-	-	
I _N (A), 60 Hz	-	-	2.5/1.4	2.8/1.6	2.3/1.3

N 630 ST.9 E | ST.13 E

PERFORMANCE DATA

Series model	Flow rate at atm. pressure (l/min) ¹⁾	Max. operating pressure (bar rel./psig)	Ultimate vacuum (mbar abs.)
N 630 ST.9 E- 50 Hz	30.0	7.0/101.5	120
N 630 ST.13 E- 50 Hz	30.0	7.0/101.5	120
N 630 ST.9 E- 60 Hz	35.0	7.0/101.5	120
N 630 ST.13 E- 60 Hz	35.0	7.0/101.5	120

¹⁾ Flow rate determined at 20 °C, 1013 mbar abs.
(Pressure 0 to 1013 mbar abs. in accordance with ISO 21360-1/2)

N 630 ST.9 E | ST.13 E

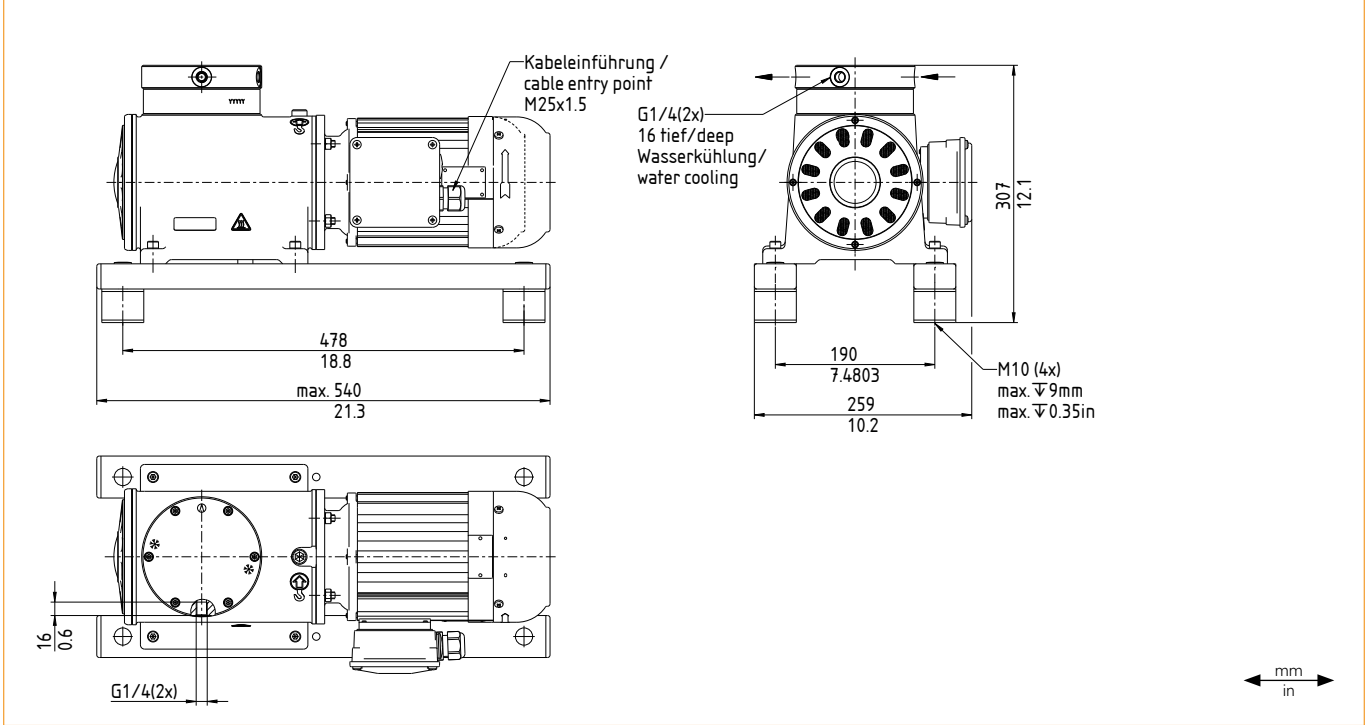

N 630 ST.9 E | ST.13 E

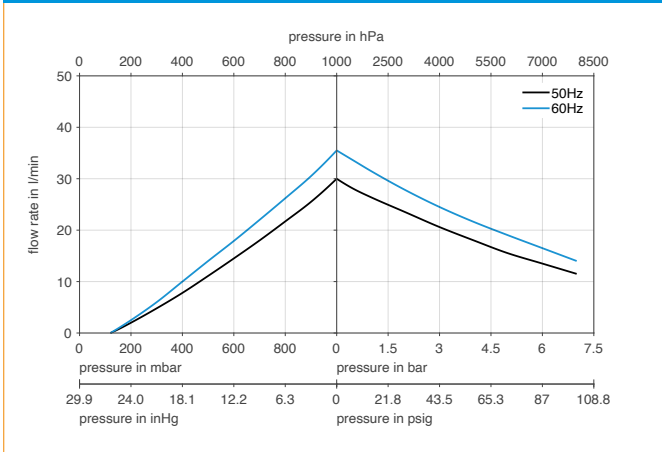

N 630 ST.9 E | ST.13 E | PUMP UP TIME FOR 20 LITER VESSEL

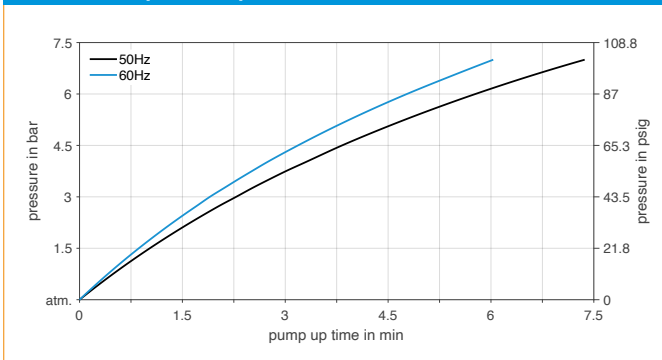

N 630 ST.9 E | ST.13 E | PUMP DOWN TIME FOR 20 LITER VESSEL

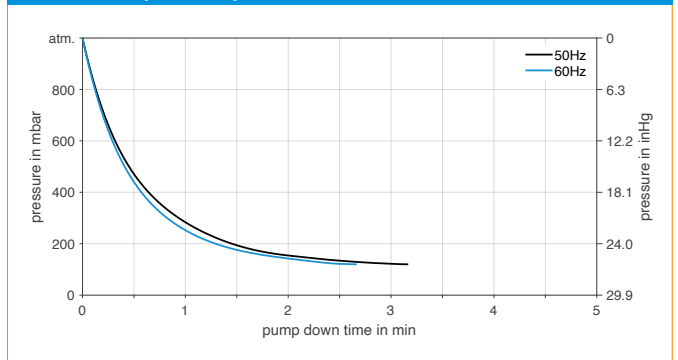

N 630 SP.9 E | SP.13 E

PERFORMANCE DATA

Series model	Flow rate at atm. pressure (l/min) ¹⁾	Max. operating pressure (bar rel./psig)	Ultimate vacuum (mbar abs.)
N 630 SP.9 E- 50 Hz	30.0	7.0/101.5	120
N 630 SP.13 E- 50 Hz	30.0	7.0/101.5	120
N 630 SP.9 E- 60 Hz	35.0	7.0/101.5	120
N 630 SP.13 E- 60 Hz	35.0	7.0/101.5	120

¹⁾ Flow rate determined at 20 °C, 1013 mbar abs.
(Pressure 0 to 1013 mbar abs. in accordance with ISO 21360-1/2)

N 630 SP.9 E | SP.13 E

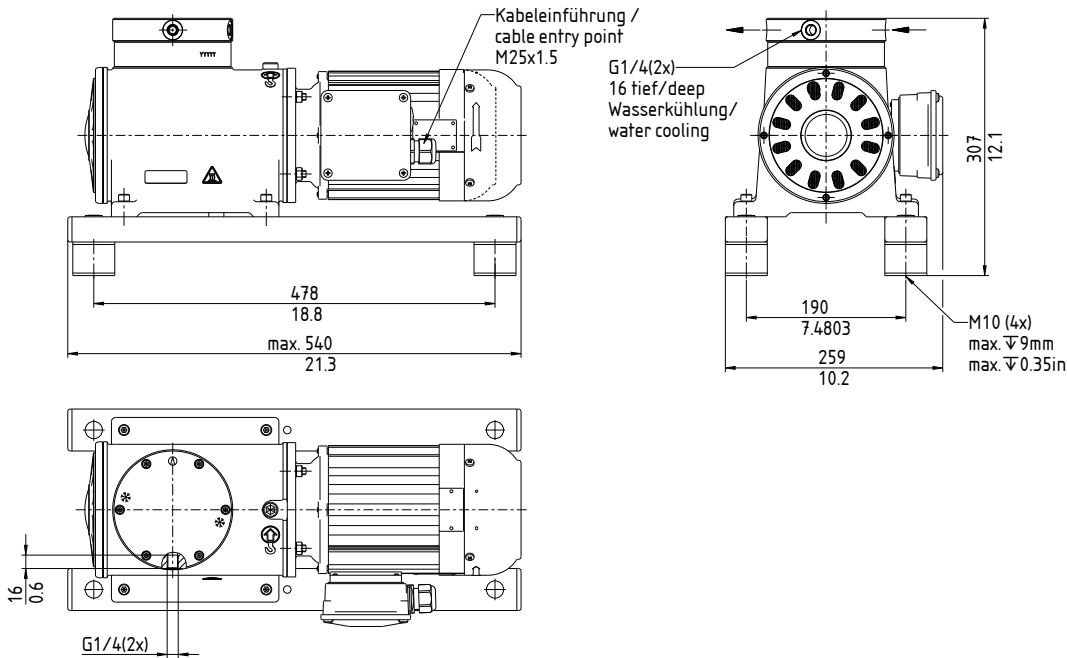

N 630 SP.9 E | SP.13 E

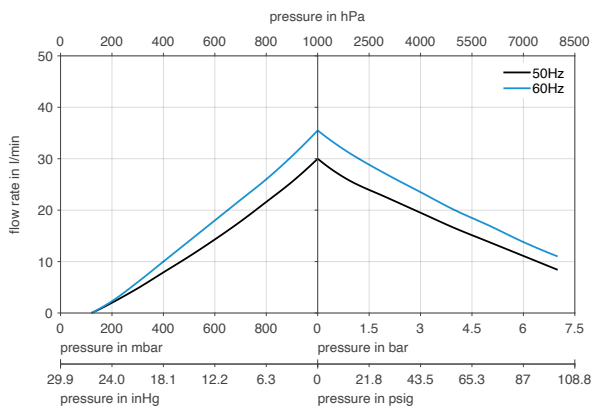

N 630 SP.9 E | SP.13 E | PUMP UP TIME FOR 20 LITER VESSEL

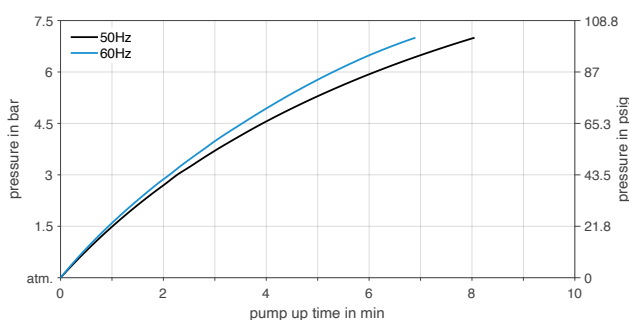

N 630 SP.9 E | SP.13 E | PUMP DOWN TIME FOR 20 LITER VESSEL

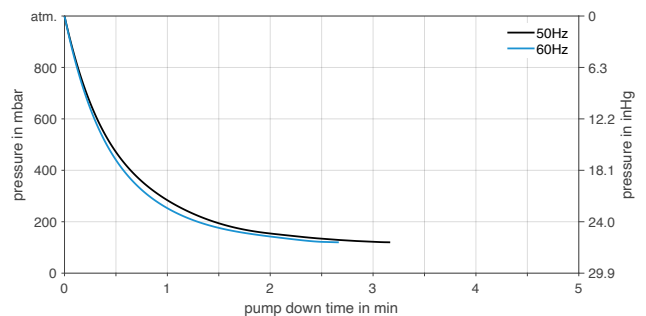

N 630 ST.12 E

PERFORMANCE DATA

Series model	Flow rate at atm. pressure (l/min) ¹⁾	Max. operating pressure (bar rel./psig)	Ultimate vacuum (mbar abs.)
N 630 ST.12 E- 50 Hz	30.0	3.0/43.5	120
N 630 ST.12 E- 60 Hz	35.0	3.0/43.5	120

¹⁾ Flow rate determined at 20 °C, 1013 mbar abs.
(Pressure 0 to 1013 mbar abs. in accordance with ISO 21360-1/2)

N 630 ST.12 E

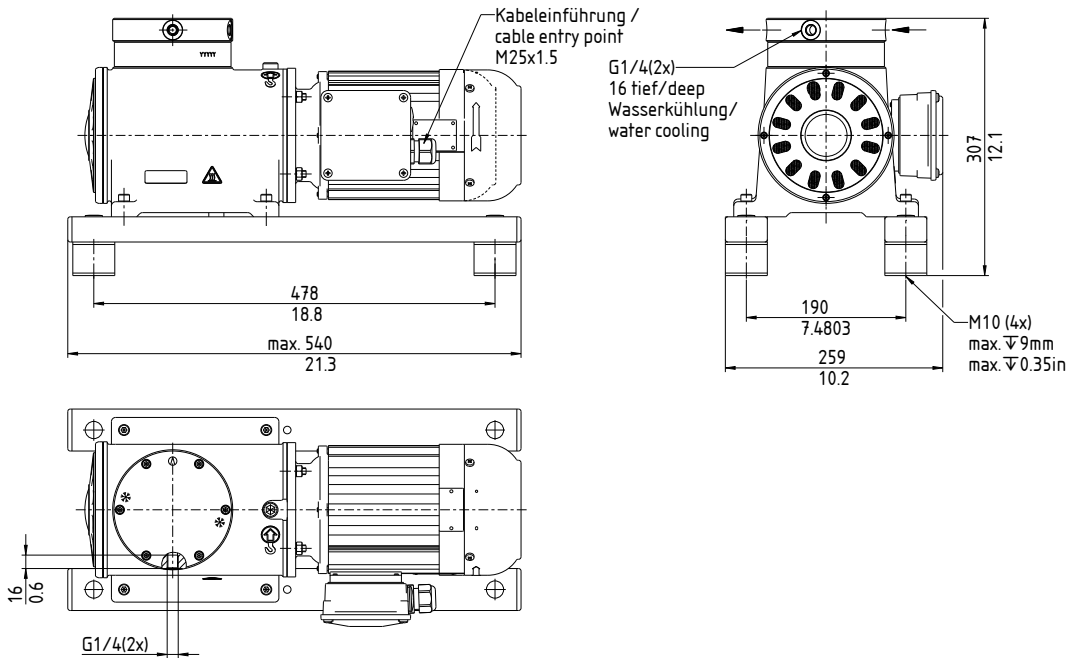

N 630 ST.12 E

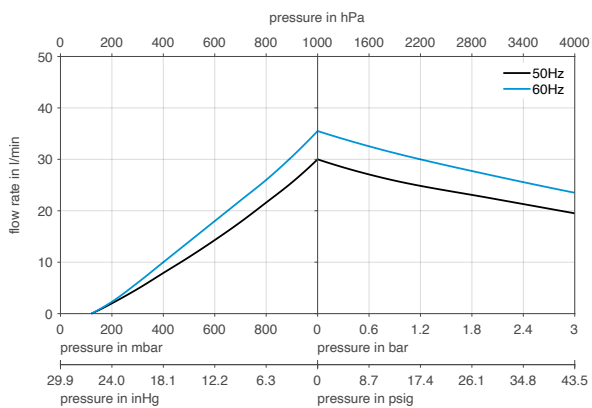

N 630 ST.12 E | PUMP UP TIME FOR 20 LITER VESSEL

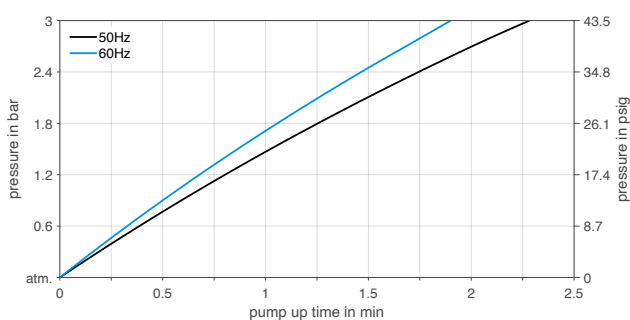

N 630 ST.12 E | PUMP DOWN TIME FOR 20 LITER VESSEL

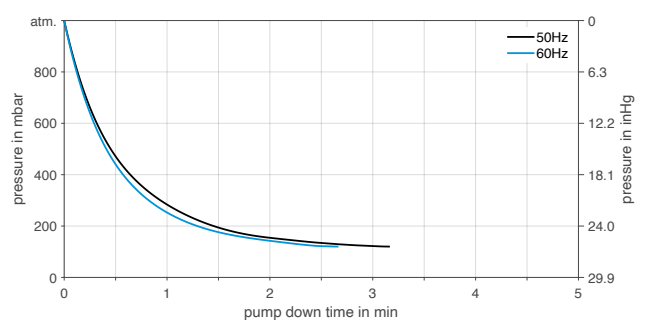

N 630 SP.12 E

PERFORMANCE DATA

Series model	Flow rate at atm. pressure (l/min) ¹⁾	Max. operating pressure (bar rel./psig)	Ultimate vacuum (mbar abs.)
N 630 SP.12 E- 50 Hz	30.0	3.0/43.5	120
N 630 SP.12 E- 60 Hz	35.0	3.0/43.5	120

¹⁾ Flow rate determined at 20 °C, 1013 mbar abs.
(Pressure 0 to 1013 mbar abs. in accordance with ISO 21360-1/2)

N 630 SP.12 E

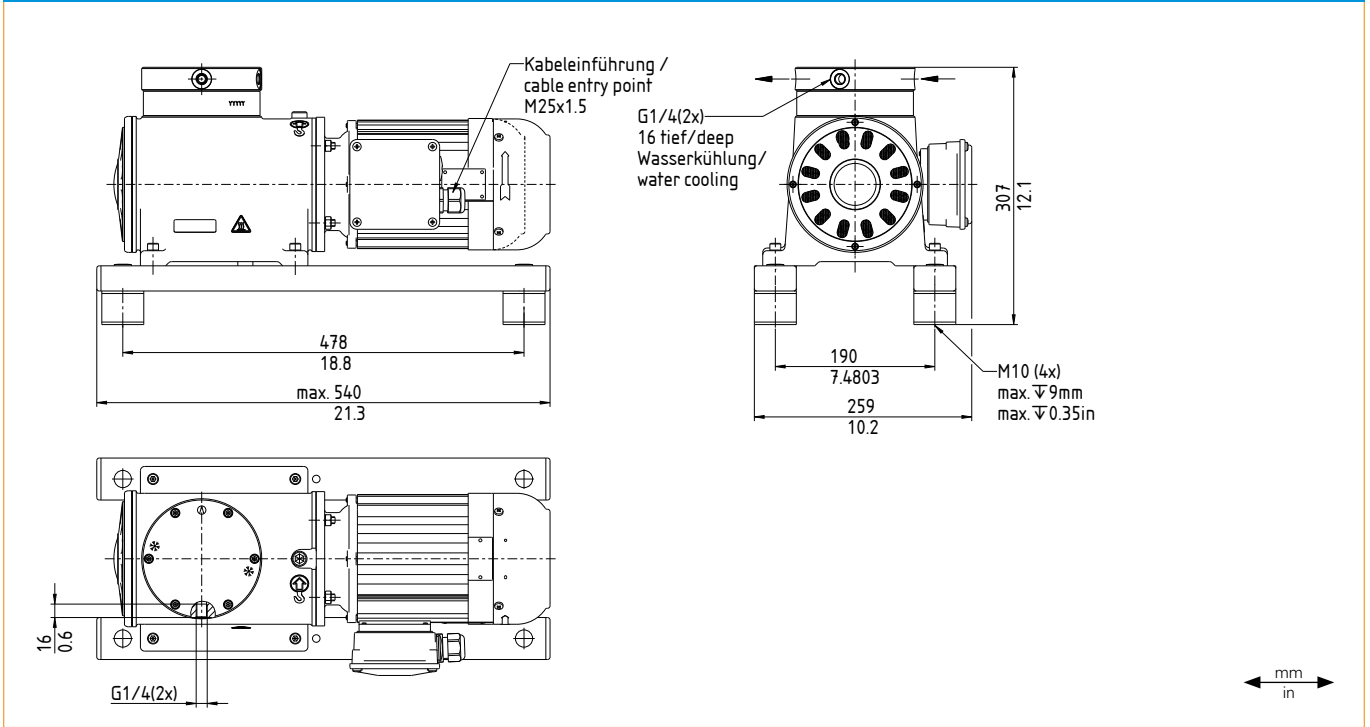

N 630 SP.12 E

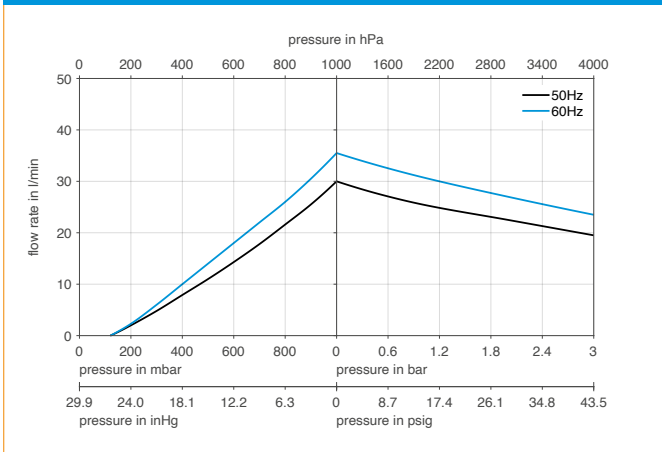



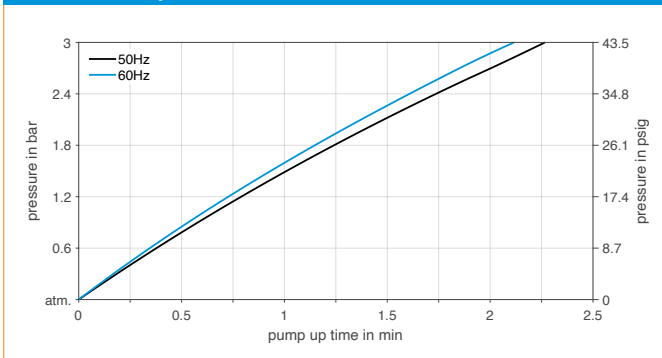

N 630 SP.12 E | PUMP UP TIME FOR 20 LITER VESSEL

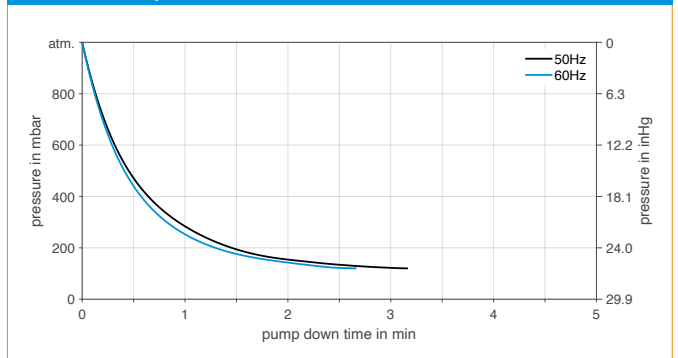

N 630 SP.12 E | PUMP DOWNTIME FOR 20 LITER VESSEL



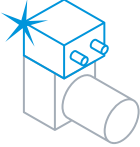
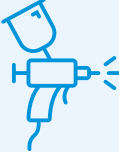



OPTIONS

Description	Illustration	Details
Mechanical adjustment of pumping capacity		The pumping capacity can be adjusted at the factory to accommodate inlet pressure and for accurate alignment with the customer's system.
Versions for special gases		Adjustment of the pump head for use with highly corrosive gases. Options include Hastelloy pump head components or coating.
Cleaned contact material parts		For the use of the pump with gases with high oxygen concentrations the parts that come into contact with the medium can be cleaned (including cleaning protocol).
Special coating		Special coatings for high corrosion protection (C4) for use in industrial areas and coastal areas with moderate salinity, such as maritime applications.
Certified head components		The components that come into contact with the medium are available with material certificates.
Special motors		Motors with special approval for maritime applications and motors with higher IP classification and insulation for tropical conditions are available on request.

ACCESSORIES

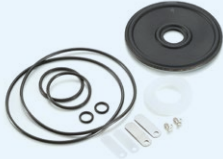
Description	Illustration	Part No.
Connection water cooling device N 630 S_.9 E S_.13 E S_.12 E		310064
Inlet filter		316661
Transport eyebolt		311535
Wrench for retainer plate		321664
Retainer plate screw N 630 S_.9 E S_.13 E		314279
Retainer plate screw N 630 S_.12 E		314280
Corrugated hose for pneumatic connection; length 400 mm		333227
Corrugated hose, certified for pneumatic connection; length 400 mm		333228

SPARE PARTS

Description	Illustration	Part No.	Details
Spare parts kit N 630 ST.9 E		321887	Spare parts kit consists of: 1x diaphragm, 2x reed valve, 2x valve stopper, 4x O-rings, 2x screws. This set is required to maintain the pump.
Spare parts kit N 630 ST.13 E		321878	Spare parts kit consists of: 1x diaphragm, 2x reed valve, 2x valve stopper, 1x PTFE washer, 6x O-rings, 2x screws. This set is required to maintain the pump.
Spare parts kit N 630 ST.12 E		325528	Spare parts kit consists of: 2x diaphragm, 2x reed valve, 2x valve stopper, 1x PTFE washer, 8x O-rings, 2x screws. This set is required to maintain the pump.
Spare parts kit N 630 SP9 E		321874	Spare parts kit consists of: 1x diaphragm, 2x reed valve, 2x valve stopper, 4x O-rings, 2x screws. This set is required to maintain the pump.
Spare parts kit N 630 SP.13 E		321875	Spare parts kit consists of: 1x diaphragm, 2x reed valve, 2x valve stopper, 6x O-rings, 2x screws. This set is required to maintain the pump.
Spare parts kit N 630 SP.12 E		321876	Spare parts kit consists of: 2x diaphragm, 2x reed valve, 2x valve stopper, 8x O-rings, 2x screws. This set is required to maintain the pump.

The performance values for the series models shown on this data sheet were determined under test conditions. The actual performance values may differ and depend in particular on the usage conditions and therefore on the specific application, on the parameters of the components involved in the user's system and on any technical modifications carried out which deviate from the standard configuration or the as delivered condition.

If individual designs have been created for specific customers on the basis of series models, other technical performance data may apply. Before operation begins, the relevant operating instructions and/or assembly or installation instructions should be read and the safety information contained in these instructions should be noted. KNF reserves the right to make changes to the product and the associated documentation without prior notice to the customer.



www.knf.com