



YOUR PARTNER
IN MEDICAL DEVICE
TECHNOLOGY
KNF GAS & LIQUID PUMPS





From diagnosis to treatment, KNF is your partner supplying customized pump solutions for device technology across a broad range of medical disciplines.

FROM DIAGNOSIS TO TREATMENT: EXPERTISE FOR LIFE

State-of-the-art medical device technology is a pillar of medical expertise. Therefore it is vitally important that these products work precisely and reliably. As suppliers of gas and liquid pumps for a broad range of medical devices from diagnosis to treatment, we take this responsibility seriously.

For decades, our tailored solutions have been used by leading global manufacturers of devices for a diverse range of medical disciplines. Our pumps perform challenging tasks, transferring gaseous and liquid media and generating vacuum and pressure.

Systems expertise for the highest quality standards

When lives are on the line, exacting standards must be met. Our highly skilled and experienced employees work meticulously to find the best possible solution for your challenge, always supported by our product centers in Germany and Switzerland. You can count on us every step of the way, from providing you with sample pumps to developing prototypes to series production. We also fully support subsequent generations of devices in order to ensure continuous improvement.

OUR STRENGTHS

Collaboration

Your personal contact will actively address your concerns. We will work closely with you to design a customized pump that can be integrated into your device technology, giving you a competitive edge in your target market. We can also help you find solutions that will make you stand out from the crowd. Our focus on service also includes customized warehouse and logistics concepts, which promote the efficiency of your production process.

Flexibility

The parameters for our gas and liquid pumps are tailored to your specific requirements – as well as to test conditions, documentation and packaging upon request. Our modular system makes it easy to supply a variety of production models whose individual components have already been tried and tested while our flexible production process allows for both small and large production numbers.

Reliability

You can count on KNF for quality, comprehensive advice and tailored solutions, as well as for reliable adherence to the applicable regulations governing medical equipment.



Precision is one of the marks of quality of KNF pumps – and vital for valid diagnostics.

PRECISION RIGHT FROM THE START

A broad range of methods are used in analysis and diagnostics. But they have one thing in common: Accurate diagnosis sets the course for effective treatment.

We do our part to ensure valid results. Durable, adjustable and precisely working KNF gas and liquid pumps prove themselves in all aspects of analysis and diagnostics – from devices for invasive or non-invasive examinations to processing procedures for liquid samples in the clinical laboratory.

Precision

We are leaders in diaphragm pump technology. We know that analysis and diagnostics place particular demands on equipment technology. This is why our pumps are designed to deliver consistent volumes of gaseous or liquid media. Each application requires specific performance parameters. Our proprietary control technology is the key for precise and adjustable control, especially with high flow rates.

Durability

Our selection of high quality pump components and materials provides the durability you need. Our gas and liquid pumps are maintenance free.

Flexible performance

Size, performance parameters, various motor designs and mechanical options – all of this can be adapted and constructed to fit your specific requirements. Our modular system offers a flexible and cost-effective selection with a price-performance ratio tailored to any set of requirements.



Fine-tuning the performance parameters of KNF pumps to match the requirements of the application ensures positive patient experience.



When used in close proximity to patients, KNF pumps impress with their pleasantly quiet, low-vibration performance.

WHEN RELIABILITY IS KEY

The reliability of KNF gas and liquid pumps is proven across a wide range of applications in devices covering all phases of treatment. We serve all medical specialties with products for the preparation and care of surgical instruments, surgical procedures including patient monitoring, irradiation technology, wound management, machine-aided intensive care, through to device technology for follow-up care.

KNF has been setting technological standards for more than half a century. The patented structured and zone diaphragms in our gas pumps achieve superior power density and gas tightness. The focus is always on safe and reliable performance, even under difficult operating conditions. When used in close proximity to patients, our micro gas pumps impress with their pleasantly quiet, low-vibration performance.



KNF pumps offer reliable performance in a wide range of medical devices used in treatment.

Following the same philosophy, our liquid pumps and diaphragm dosing pumps have been developed further to improve diaphragms and valves in particular. The dosing pumps can reliably meter even the smallest amounts with high repeatability – even in constant operation.

Reliability

We will implement your precise specification, ensuring that the KNF pump reliably performs the defined task. Medical applications benefit from the fundamental advantages of our diaphragm technology:

- no contamination of media
- outstanding gas tightness
- can be mounted and operated in any position
- self-priming and able to operate dry for liquid applications
- moisture insensitive for applications using gas

Stability

Our comprehensive expertise in the areas of mechanics, materials, fluidics, pneumatics, electronics and software development ensures continued advancement of technologies and solutions.

High performance

Whether used in close proximity to the patient, built into a wearable medical device, or used to ensure safe irradiation processes – the functionality of KNF gas and liquid pumps provides the performance you need.

RESPOND TO MARKET DEMANDS AND CHANGES WITH NEW PRODUCTS
FROM KNF – YOUR PARTNER IN MEDICAL DEVICE TECHNOLOGY



Micro diaphragm gas pumps with DC-BI motor technology

For the most demanding applications where long service life,
a small footprint and advanced controllability are needed.

CONSISTENTLY MARKET-ORIENTED WITH A FOCUS ON YOUR REQUIREMENTS

Our goal – Your added value

We see ourselves as your partner for custom-fit pump solutions in the field of medical device technology. For us, being a partner means providing competent and confidential support throughout all phases of device development as well as with subsequent generations of devices. It also means that we recognize changes in the market and respond with appropriate, constructive solutions. Our goal is to create advantages that provide you with added value.

Custom-fit solutions

To develop our custom-fit solutions, we analyze the market requirements that you must meet as a device manufacturer and gain a sense of what users – your customers – expect from the devices. The results serve as the starting point for redefining the technical and economic specifications of the products, as necessary. In pursuit of our goal, we fundamentally reevaluate the status quo and systematically adjust our approach – from the design to the production process to logistics.

THE DIAPHRAGM – THE CENTERPIECE OF EVERY PUMP



Continuous development

The diaphragm is the centerpiece of every pump. This hard-working component is essential for ensuring the pump works efficiently, which is why KNF works diligently to further advance its technology. From flat diaphragms, molded diaphragms and structured diaphragms to zone diaphragms and oval diaphragms, each diaphragm shape boasts its own specific advantages in order to meet the requirements of their various fields of application.

MATERIAL OPTIONS

Valve/Diaphragm:
EPDM, FKM, FFKM,
HNBR, stainless steel
and others

Pump head:
PP, PPS, fluoroplastics,
stainless steel,
aluminum and others

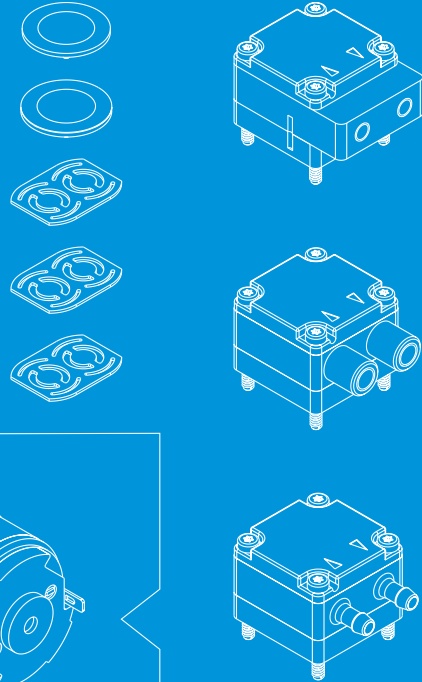

MECHANICAL OPTIONS

Circuit points and connections

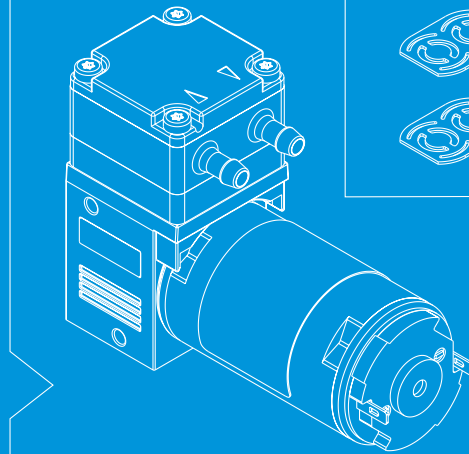
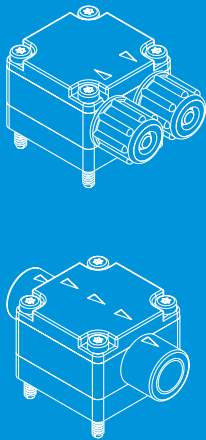

MOTOR OPTIONS

“DIGITAL CUSTOMIZATION” sets our brushless DC motors apart, allowing for their unique configuration. And we do mean unique. We develop and produce these motors ourselves or as part of an exclusive development partnership with a leading motor manufacturer. These motors map complex operating profiles, including required safety parameters. Your advantage: high energy efficiency, precisely controlled target variables and simple control via digital signals.

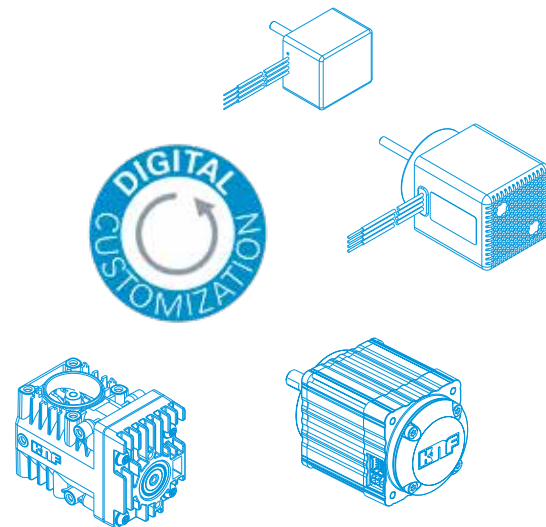

Explosion-proof versions and all common voltage configurations available.
Motor types: DC, DC-B, AC.

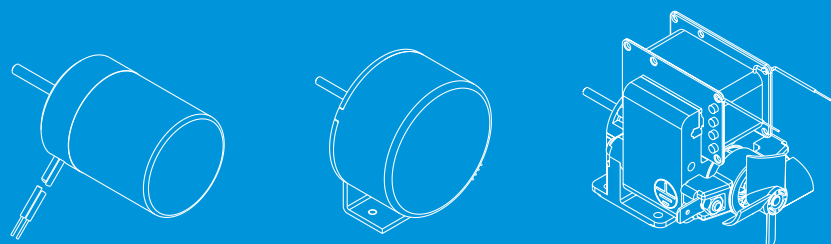

FLEXIBLE, CUSTOM-FIT, COST-EFFECTIVE – FROM STANDARD TO HIGH-END

Every application is different and some are one of a kind. Our modular system is designed to give you a high degree of flexibility, speed and reliability. You can be sure that every gas and liquid pump supplied by KNF will exactly meet your requirements, no matter how complex or unusual these might be.

Series models – the first step to customized pumps

KNF offers a range of up to 90 series models designed for handling gases and liquids. The performances of these are described in our data sheets.

The KNF modular system for creating customized pumps

By selecting and combining a variety of options, ranging from the material used to make the pump components that come into contact with the media, to the drive and the mechanical elements such as the circuit points and connections, it is easy to tailor every series model to meet application-specific requirements. The configurations created by the KNF modular system are based on tried and tested individual components, meaning that developing customized pumps is quick and inexpensive.

Project pumps – precisely designed for the application

We support your development project by providing you with sample pumps quickly and easily. In consultation with you, our employees from the sales, engineering, and product management divisions determine the modifications to be made to the product's standard technical parameters.

FLEXIBLE SUPPORT FROM START TO FINISH – YOUR ADDED VALUE IS OUR PRIORITY

WITH KNF, FLEXIBILITY DOESN'T STOP AT THE TECHNICAL SOLUTION. WE FULFILL YOUR INDIVIDUAL REQUESTS EVERY STEP OF THE WAY UNTIL DELIVERY AND SERVICE.

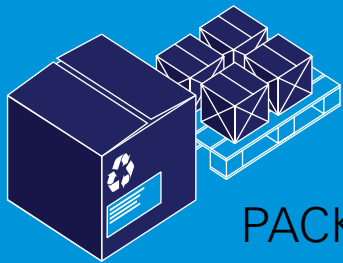

PACKAGING

We'll be happy to implement any measures that make life easier for your goods receiving department, as well as to support your efforts toward recycling and environmental protection.

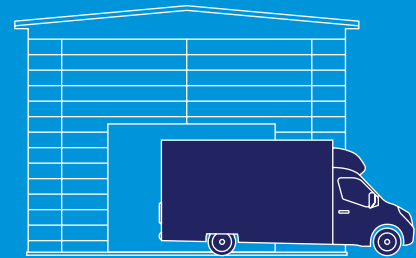

LOGISTICS

We support all types of production lot ordering – including Kanban, VMI, CMI, B2B and others.



DOCUMENTATION

Together, we'll define the type, scope and design of the documentation.



We inspect and test 100% in line with your requests.



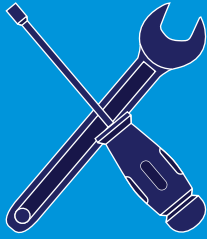

SERVICE

We implement custom-fit service concepts for you. It is important to us to minimize the overall running costs of our pumps, and we take this into account in the pricing of replacement parts.

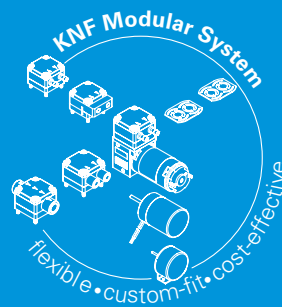
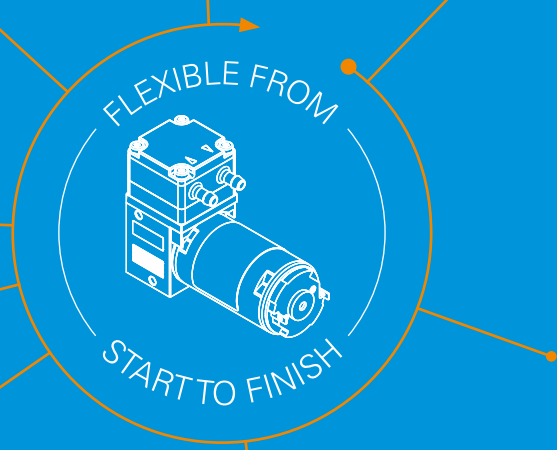

~3,000

customized adaptations are carried out at KNF every year for all our customers worldwide – quickly and inexpensively thanks to our modular system. We also develop exclusive pumps and drive concepts for individual customers.

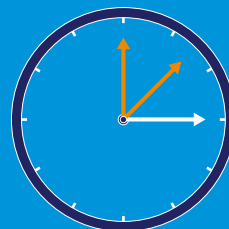

“ASSEMBLY AND ENGINEERING IN ONE”

We will provide you with the pump as an assembly. This may include completing steps in the production process or installing components such as a valve block, sensors, tubing etc.

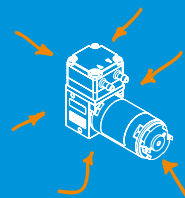

≥1



PRODUCTION

You can rely on the flexibility and quality of our support for every order with KNF, from large lot sizes to a single pump.

OUR BEST PUMP SERIES MODELS FOR MEDICAL DEVICE TECHNOLOGY

Thanks to the KNF modular system, each of our series models can be quickly and easily adapted to suit the specific needs of an application.

TRANSFER, EVACUATION & COMPRESSION OF NEUTRAL/AGGRESSIVE GASES

	Type	Flow rate at atm. pressure (l/min)	max. vacuum (mbar abs.)	atmospheric pressure	max. pressure (bar g)
Micro diaphragm pump	NMP to NMS	0.3 – 16	40		3
Mini diaphragm pump	N 85.3 to N 936	3 – 60	15		4
Multi-stage diaphragm pump for deep vacuum and high flow rate	N 84.3 to N 880	4.2 – 80	0.5		1



Micro diaphragm pump



Micro diaphragm pump



Mini diaphragm pump



Multi-stage diaphragm pump

	Type	Flow rate at atm. pressure (l/min)	max. vacuum (mbar abs.)	atmospheric pressure	max. pressure (bar g)
Swing-piston compressors & vacuum pumps	NPK 03 ... 09.1.2	2.7 – 24	100		7



Swing-piston compressor & vacuum pump



Swing-piston compressor & vacuum pump

TRANSFER & METERING OF NEUTRAL/AGGRESSIVE LIQUIDS

	Type	max. flow rate at atm. pressure (l/min)	max. pressure (mWg)	max. suction height, self-priming (mWg)
Solenoid diaphragm liquid pumps	FMM 20 to FL 10	0.018 - 0.1	10	4
Diaphragm liquid pumps (two pump heads)	NFB 5 to NFB 100	2 x 1.3	10	6
Diaphragm liquid pumps	NF 5 to NF 1.300, FP 7 to FP 1.400	0.005 – 4.6	60	6
Diaphragm liquid pressure pump	NF 2.35	350	16 (bar)	3



Solenoid diaphragm liquid pump



Diaphragm liquid pump (two pump heads)



Diaphragm liquid pump



Diaphragm liquid pump



Diaphragm liquid pressure pump

	Type	Dispense volume at atm. pressure (µl)	Dosing rate at atm. pressure (ml/min)	Pressure height (mWg)
Micro diaphragm metering pump (stepper motor-driven)	FEM 1.02 ... 1.09	5 – 520	0.2 – 90	60



Micro diaphragm metering pump (stepper motor-driven)



Scan the QR code to find the perfect KNF liquid pump or gas pump for your project in no time.

